



# ProParts<sup>®</sup> Direct<sub>net</sub>

A Division of YC Power & Associates

Llámanos hablamos español en español!



@bestbuddycutters

**(800) 305 9255 | WWW.PROPARTSDIRECT.NET**

**TORO DINGO ATTACHMENT PLATE**

**QUICK ATTACH PLATE**

Toro Dingo Quick Attach Plate. Used to mount attachments to all Dingos.



**Order Number: 132-8418**

**Price: \$1219.95**

**Z-SPRAY PARTS IN-STOCK**



Front Caster  
Wheel fits  
Z-Spray  
Models  
Replaces 135-5974



**Order Number: 142-5509**

**Price: \$126.99**

**THE BEST BLADE DEALS**

**MOWER BLADES**



**AS LOW  
AS  
\$9.99  
ea.**

Commercial Blades for Exmark, Toro, Scag, Wright, Snapper Pro, Ferris, Walker and more....



**WALKER  
TINE DETHATCHER**

Fits all Walker mowers.  
40" Wide dethatcher.

**Order Number: A10**

**Price : \$799.99**



**Kinetix**

**TWO CYCLE FUEL**

**Synthetic 2-Cycle Oil**

Part Number: 80012  
Fully Synthetic with Fuel Stabilizer. Meets/  
Exceeds JASO FD, ISO-L-EGD  
& API-TC Classifications

2.6 oz. Bottle ( 1 gal Mix)

**Sale Price:**

**Case Qty. 48:**

**\$2.39 ea.**

**\$95.04**

**\$1.98 ea.**  
w/ Case Pricing



**SAVE  
\$.41  
PER BOTTLE W/  
CASE PRICING**

**Your One-Stop-Shop for All Commercial Landscape Parts & Accessories!**

**THE RIGHT PART, THE RIGHT PRICE..... EVERY TIME.**

# Kinetix

HIGH PERFORMANCE OILS



Our Zn™ additive activates as engine temperatures rise creating a chemical barrier that guards critical metal engine components from the wear caused by high pressure, heat, and friction.



SAE 30 Oil	Single Price	Case of 12
80003 - Quart	\$6.95	(\$5.89 ea.) <b>\$70.68</b>
80022 - 5 Gallon Pail	\$129.95	
5W-30 Oil		
80014 - Quart	\$6.95	(\$5.89 ea.) <b>\$70.68</b>
80020 - 5 Gallon Pail	\$129.95	
80025 - 55 Gal Drum	\$1399.95	
10W-30 OIL		
80001 - Quart	\$6.95	(\$5.29 ea.) <b>\$63.48</b>
80021 - 5 Gallon Pail	\$99.95	
10W-40 Oil		
80017 - Quart	\$6.95	(\$5.89 ea.) <b>\$70.68</b>
80033 - 55 Gal Drum	\$1399.95	
15W-40 Oil		
80005 - Quart	\$7.95	(\$6.29 ea.) <b>\$75.48</b>
80028 - 5 Gallon	\$159.95	
20W-50 Oil		
80007 - Quart	\$7.95	(\$6.49 ea.) <b>\$77.88</b>
80032 - 55 Gal Drum	\$1499.95	



### Bar Oil

Order Number: 80009  
TAKFLO Additive for supreme tack  
Red Colored Oil  
1 qt. Bottle

**Sale Price:**  
**12 or more:**

**\$4.89 ea.**  
**\$4.59 ea.**



### Bar Oil

Order Number: 80010  
TAKFlo Additive for supreme tack  
Red Colored Oil  
1 Gallon bottle

**Sale Price:**  
**12 or more:**

**\$15.89 ea.**  
**\$14.89 ea.**



## Kawasaki K-Tech Oil

Semi-synthetic, 50: 1 oil. Premium 2 Cycle Oil exceeds the rigorous requirements of API TC, JASO FD and ISO EGD classifications for 2-cycle air-cooled small engine applications. Reduced lacquer and varnish build up. Rust and corrosion inhibitors, Low Smoke Formula

Order Number	Description	Price Each	Quantity Discount
99969 6082C	48 Bottles, 1 Gallon Mix	\$2.39	48 or more \$1.98 ea
99969 6084C	48 Bottles, 2.5 Gallon Mix	\$3.29	48 or more \$2.49 ea
99969 6085C	24 Bottles, 5 Gallon Mix	\$5.09	24 or more \$4.69 ea
99969 6086D	1 Gallon Jug - 3 Per Case	\$49.95	3 or more \$45.95 ea
99969 6157C	5 Gallon Pail	\$179.95	



## ECHO® Power Blend Gold Oil

50: 1 oil. Premium 2 Cycle Oil. Meets or exceeds ISO-L-EGD- and JASO M345/FC standards. The oil includes a fuel stabilizer to maintain fuel's quality. Use to minimize exhaust-port blockage, protect engine components and keep fuel burning clean

Order Number	Description	Price Each	Price Per Case
6450001	48 Bottles, 1 Gallon Mix	\$1.99	(\$1.77 ea) \$84.96
6450025	48 Bottles, 2.5 Gallon Mix	\$2.73	(\$2.54 ea) \$121.92
6450005	12 Bottles, 5 Gallon Mix	\$5.89	(\$5.10 ea) \$61.20
6450050	1 Gallon / 4 Per Case	\$43.95	
6450250	5 Gallon Pail	\$195.00	



## Kinetix Zinc Oil

### Synthetic 2-Cycle Oil

Fully Synthetic with Fuel Stabilizer. Meets/Exceeds JASO FD, ISO-L-EGD & API-TC Classifications

Order Number	Description	Price Each	Price Per Case
80012	48 Bottles, 1 Gallon Mix	\$2.39	(\$1.98 ea) \$95.04
80013	24 Bottles, 2.5 Gallon Mix	\$3.49	(\$2.99 ea) \$71.96
80011	24 Bottles, 5 Gallon Mix	\$5.95	(\$4.59 ea) \$110.16

# Kinetix



## Redmax MaxLife 2 Cycle Oil

RedMax Synthetic Blend 2 Stroke Engine Oil was engineered to actively combat the negative aspects of ethanol blended fuel. Its fuel stabilizer additives offer protection against fuel oxidation (gum formation, sour gas) and system corrosion.

Order Number	Description	Price Each	Price Per Case
598817701	48 Bottles, 1 Gallon Mix	\$2.39	(\$2.09 ea) \$100.32
598817703	48 Bottles, 2.5 Gallon Mix	\$3.39	(\$3.09 ea) \$148.32
598817704	12 Bottles, 5 Gallon Mix	\$6.59	(\$6.19 ea) \$74.28
598817705	1 Gallon Jug (4 per case)	\$49.95	



## OIL MEASURING CUP



**4 Fl. oz Capacity**  
**Order Number:**  
 6450009  
**Price: \$1.69**

## OIL PAIL DISPENSING PUMP

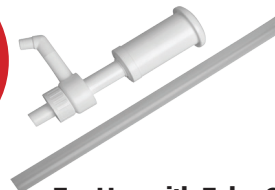

**For 5 gal. pail**  
**Order Number:**  
 99909-0010  
**Price: \$34.89**

For Use with Echo Oil Only

# Jrco

Heavy-duty Attachments  
for Commercial Mowers



## Tine Rake Dethatcher

Universal Tine rake will fit all most all commercial mowers. The rake quickly attaches to the machines using a universal mount bar. The dethatcher can be used all year long! Includes mount bar.

Deck Size	Size	Shipping Weight	# Of Tines	Price
Compact	36"	75 lbs	27	\$899.00
40, 46, 48, 50, 52, 54	46"	83 lbs	35	\$899.00
60, 66, 72	60"	93 lbs	47	\$955.00

When ordering rake dethatcher, you will need to supply the following information: \* Manufacturer of Mower \* mower # serial number \* Deck Size \* Type of deck \* bagging system or not

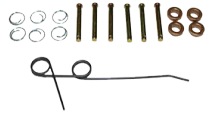

## Tune-Up Kits

Order Number	Description	Price
1148	Leaf Plow Tune Up Kit - Includes Left & right Tine Set, 2 skid wheels, 4 oil-lite flange bushings, 2 clevis pins & circle cutters	\$142.80
1136	Tine Rake Tune Up Kit - 36" Includes 27 Double Loop Tines, 4 oil-lite flange bushings, 6 Clevis Pins and circle cutters	\$92.40
1146	Tine Rake Tune Up Kit - 46" Includes 35 Double Loop Tines, 4 oil-lite flange bushings, 6 Clevis Pins and circle cutters	\$117.60
1160	Tine Rake Tune Up Kit - 60" Includes 47 Double Loop Tines, 4 oil-lite flange bushings, 6 Clevis Pins and circle cutters	\$152.25



Order Number	Description	Price Each	24 or More
4624DD	Replacement Double Loop Tines	\$2.95	\$2.49

## Dual Wheel Velke

Dual Wheel Velke's give more stability than a single wheel and leave a nice track behind any walk behind mower. Operator Capacity = 250 lbs. Only in black

Order Number: VKX2

Price . . \$489.95 ea.



## Steel Grass Catchers Heavy-Duty Metal Great Handle Design

Order Number	Description	Price
<b>Exmark ( Bracket Included)</b>		
UNI4300	4.3 cu ft, Fits Exmark, Early Bobcat, Kees Encore	\$359.99
UNI5800	5.8 cu ft, Fits Exmark, Early Bobcat, Kees Encore	\$459.99
<b>Gravely</b>		
GRA4300	4.3 cu, ft	\$359.99
GRA5800	5.8 cu ft,	\$459.99
GRA5800-15	5.8 cu ft, Pro-Turn, Pro-Stance Mower	\$459.99
<b>Ferris ( Bracket Included)</b>		
SCG4300	4.3 cu ft, Fits Ferris Mowers Decks	\$359.99
SCG5800	5.8 cu ft, Fits Ferris Mowers Decks	\$459.99
<b>Scag ( Bracket Included)</b>		
SCG4300	4.3 cu ft, Fits Ferris Mowers & Scag Regular Decks	\$359.99
SCG5800	5.8 cu ft, Fits Ferris Mowers & Scag Regular Decks	\$459.99
SCGA4300	4.3 cu ft, Fits Scag Advantage Decks	\$359.99
SCGA5800	5.8 cu ft, Fits Scag Advantage Decks	\$459.99
SCGV4300	4.3 cu ft, Fits Scag Velocity Decks	\$359.99
SCGV5800	5.8 cu ft, Fits Scag Velocity Decks	\$459.99
<b>Toro ( No Bracket Needed)</b>		
TOR4300	4.3 cu ft, Fits Toro Turbo Force Decks	\$359.99
TOR5800	5.8 cu ft, Fits Toro Turbo Force Decks	\$459.99
<b>Wright ( No Bracket Needed)</b>		
WRI4300	4.3 cu ft, Fits Wright, Early Bobcat, Kees, Encore	\$359.99
WRI5800	5.8 cu ft, Fits Wright, Early Bobcat, Kees, Encore	\$459.99



Order Number  
103000  
Price  
**\$439.95**



## ProSlide Wear Plate

Replacement Plastic Wear Plate for ProSlide.

Order Number 103038

Price . . . \$97.99

## ProSlide XT

The ProSlide offers great looking Professional lawn striping with the cost saving benefits of a velke wheel. Gas loaded spring folds slide up nicely.

Order Number	Description	Price
102028	Gas Spring	\$36.29
103036	XT Torsion Spring Kit	\$15.99

# Leaf Plows

The heavy-duty JRCO Leaf Blade Plow uses the mower's power to quickly move piles of leaves. It virtually eliminates "tarping" and moves windrowed leaves for collection. The one-piece. Does not include Mount bar.

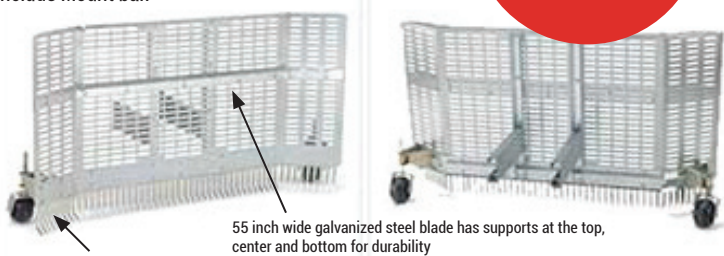

Stainless steel spring tines allow the plow to push leaves on even surfaces.

55 inch wide galvanized steel blade has supports at the top, center and bottom for durability

Order Number  
480  
**Price**  
**\$649.95**

**JrcO**  
Heavy-duty Attachments  
for Commercial Mowers



## Mount Bar Package

Required for all Front mount attachments  
One mount bar need per mower model  
Includes all hardware and brackets

**Price \$227.00** Call or go online for proper mount bar for your machine.

# Blower Buggy Carrier

Designed to hold walk-behind blowers on the front of zero-turn and riding mowers.  
Moves yard debris with speed and ease.  
Buggy adjusts to fit most blowers.  
One person can quickly unload and load  
Quickly attaches to JrcO mount bar with 2 pins  
JrcO mount package sold separately.

## BLOW DEBRIS WITH SPEED & EASE

Order Number  
601  
**Price**  
**\$849.95**

@mowbroslawncare

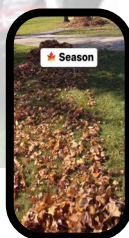

Order Number  
751  
**Price**  
**\$2899.95**



## Hooker Aerator

38" Wide Aerator, six tine rotors, front-mount  
Aerate 66,000 sq ft per hour at 5 mph.  
Punctures up to six holes per sq ft.  
Holes approximately 1/2" wide x 1-1/4" long and up to 3" deep.  
Casters swivel allowing turning while aerating  
Six floating rotor heads independently to life over tree roots and rocks while the other heads continue to aerate.  
Electric actuator lifts the heads for transport.  
JrcO mount bar sold separately.

Order Number	Description	Price
15W	Deckless Aerator Mount for Walker Mower	\$433.00



## Hooker Tow-Behind Aerator

38" Wide Aerator, six tine rotors, front-mount  
Aerate 66,000 sq ft per hour at 5 mph.  
60" Wide aerates 105,000/hr at 5 mph.  
Punctures up to six holes per sq ft.  
Holes approximately 1/2" wide x 1-1/4" long and up to 3" deep.  
Six floating rotor heads independently to life over tree roots and rocks while the other heads continue to aerate.  
Electric actuator lifts the heads for transport.  
JrcO mount bar sold separately.



Order Number	Description	Price
753	38" Tow-Behind Aerator, Includes Hitch	\$3200.00
755	60" Tow-Behind Aerator, Includes Hitch	\$4910.00

# Jacks & Ramps

## MoJack PRO Mower Lift

The MoJack PRO Mower Lift is designed to be smarter and work harder. Make working on your lawn tractor safe and easy. This lift is ideal for blade sharpening, belt replacement, debris removal, and lawn mower maintenance. Safer and more convenient than makeshift mower jacks, car ramps or concrete blocks, it features a self-braking winch and ratcheting safety-lock to prevent the machine from slipping or becoming unstable while performing maintenance. The winch makes lifting quick and easy, even if it's used several times a day.

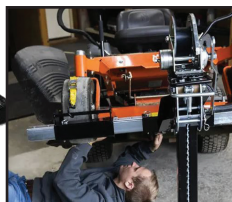

- Lifting capacity: 750 lbs (lifting front end only, not total weight of mower)
- Lifting Height: 25"
- Fits any lawn tractor or ZTR riding mower on the market
- Wheel Span Measurement: 31.5" – 62.5" outside front wheel measurement
- Easily lifted with one hand or a power drill
- Folds flat for easy, compact storage

**Order Number: MJPRO**

**SALE PRICE: \$629.95**

## MoJack EZ MAX

- Lifting Capacity: 450 lbs (lifting the front of the mower, not the total mower weight)
- Lifting Height: 24"
- Fits most residential tractor and ZTR mowers
- Easily lift manually or with a powered drill
- Folds flat for easy storage
- Wheel Span Measurement: 18.5" – 47.5" (inside to outside front tires)

**Order Number: 45001-EZMAX**

**SALE PRICE: \$349.99**



## MoJack Work Bench Attachment

The MoJack Workbench Attachment smartly converts your MoJack lawn mower lift into a sturdy worktable for push mowers and other small projects. The MoJack Workbench Attachment is engineered to put everything at a comfortable working height. The MoJack Workbench Attachment is compatible with MoJack EZ, MoJack EZ MAX, MoJack XT, MoJack XT 750, and MoJack PRO lifts.

**Order Number: MJWORKBENCH**

**SALE PRICE: \$159.99**

# ULTRA-TOW™

## CARGO RAMPS

Ideal for Loading ATV's, Mowers and Landscaping equipment. Folding design is light weight & high strength.

41197



53181



53187



41156



## Ultra-Tow Cargo Carrier



- Durable aluminum construction is lightweight and rust & corrosion-resistant
- 500-lb. capacity (equally distributed) allows you to haul large loads
- 8in. high side rails contain cargo
- Hitch mount design is compatible with cars, trucks, vans and SUVs with a 2in. dia. receiver hitch
- Rear safety reflector provides increased night visibility for added safety

**Order Number: 28679.ULT**

**SALE PRICE: \$159.99**

Order Number	Capacity	Material	Folding	Length	Weight	Price
41197.ULT	500 lbs	Aluminum	Tri-Fold	77 in	29 lbs	\$249.95
53181.ULT	750 lbs	Aluminum	Half Fold	90 in	31 lbs	\$235.00
53187.ULT	1,500 lbs	Aluminum	Half Fold	96 in	62 lbs	\$399.95
41156.ULT	500 lbs	Steel Gal Finish	Tri-Fold	72 in	47 lbs	\$169.95



**PL1800H-V**

Order Number	Description	Price Each
G382244-S	TINE (Uses 4) 5/8	\$32.97



**PL2500H/SPH**

Order Number	Description	Price Each
G382244-S	TINE (Uses 8) 5/8	\$32.97



**AE1300H/AE401-V**

Order Number	Description	Price Each
G360100	TINE (Uses 8)	\$12.50



**CR POWER RAKES**

Order Number	Description	Price Each
G350251-S	Flail Blade Kit Set of 30	\$112.60
G350187	Slicing Blade Kit Set of 20	\$177.10



**PR POWER RAKES**

Order Number	Description	Price Each
G350356-S	Spring Tine Kit	\$199.90
G350187	Slicing Blade Kit Set of 20	\$177.10
G350186	Flail Blade Kit Set of 30	\$149.95



**18" Walk-behind Aerator**

Order Number	Description	Price Each
126-2143	TINE Uses 24	\$9.99
121-1869	Flail Blade Uses 32	\$4.97

## Dual-Purpose Pintle Hitch



The Ultra-Tow® 6-Ton Dual-Purpose Pintle Hitch can be used with a tow ring or ball coupler. U.S.A.

**Order Number: 23261.ULT**

**SALE PRICE: \$125.00**



**Hooker Aerator**

Order Number	Description	Price Each
7860-1	TINE Gen2 (Uses 6)	\$43.58
7860-2	Tine Gen 3	\$44.47
7860	Tine Gen 4	\$38.85



**30" Stand-On Aerator**

Order Number	Description	Price Each
126-2143	TINE (Uses 24)	\$9.99

## Re-Usable Ear Plugs

Quattro EP-401 Reusable Ear Plugs. Conforms with CE standards and can be used in the EU. These reusable ear plugs are ideal for use with outdoor power equipment and have a noise reduction rating of 27 decibels. The range of noise reduction ratings of existing hearing protectors are approximately 0 to 30. (higher numbers denote greater effectiveness).

**Box of 100**



**Order Number  
16190  
Price  
\$129.95**



# PARTS FOR BILLY GOAT, SCAG, GIANT-VAC, LITTLE WONDER TRUCKLOADERS



Fan fits 12HP & 13 HP Billy Goat Truck loaders. Models TR1204L and TR1304H.

Order Number G810974  
**PRICE \$395.85**



## SCAG GIANT-VAC

Fan fits Skid Mount and Tow Behind TLS20W models. Requires hub.

Order Number 452454  
**PRICE \$549.95**

Hub - Order Number 484820



## LITTLE WONDER®

Fan fits Little Wonder / Monster 29HP Truck Loaders.

Order Number MP020025  
**PRICE \$1,188.00**

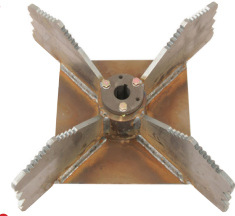

Order Number	Impellar Fans - Model Fitment	Price
G810629	TR1104	\$298.00
G810974	TR1204L / TR1304H	\$395.85
G810930	HTR1803V / 1803VEU	\$419.95
G812257-S	DL1201 / DL1301H	\$449.95
G810930	DL1401SE/ DL1801VE	\$419.95
G791120-S	DL1800V / DL2500S	\$789.95
G792601	DL3500V	\$889.95

Order Number	Impellar Fans - Model Fitment	Price
452454	TLS20-18BV, TLH20-18BV	\$549.95
452455	TLS20-29BV, TL20W-26EFI	\$529.95
452445	TLB25-35BV, TLB25-37CH, TLB25-48KBD	\$879.95
Hub		
484819	TLS20-18BV, TLH20-18BV	\$104.21
484820	TL20W-29BV, TL20W-26EFI	\$189.84
Impellar Bolt & Keyway Kit		
462592	TLS20-18BV, TLH20-18BV, TL20W-29BV, TL20W-26EFI	\$48.65
Impellar Carriage Screw		
04015-22	TLS20-18BV, TLH20-18BV, TL20W-29BV, TL20W-26EFI	\$3.32

Order Number	Impellar Fans - Model Fitment	Price
MP020028	8183-04-01, 8185-04-01	\$885.47
MP020025	8293-04-01, 8295-04-01	\$1120.44
LW4168402	8160-00-01, 8180-00-01	\$667.68
LW4167583	8161-00-01, 8181-00-01	\$684.00
LW4168330	8272-00-01 ( Includes Talon)	\$1168.80

## REPLACEMENT PARTS

Order Number	Description	Price
G790167	DL1201/DL1301H Impeller screw	\$3.26
G8177012	DL1201/DL1301H Washer	\$0.63
G9201125	DL1201/DL1301H KeyWay	\$1.68
G812283	DL1401SE/ DL1801VE Debris Reducer	\$61.95
G9201125	DL1401SE/ DL1801VE Keyway	\$1.68
G9201125	DL1800/ DL2500S Keyway	\$1.68
G812221	DL1201L / DL1301 Insert Liner	\$169.97
G812214	DL1401 Insert Liner	\$169.97
G812391-S	DL1800V / DL2500 Insert Liner	\$189.49

## REPLACEMENT PARTS

Order Number	Description	Price
Long Wear Liner		
426310	TLS20-18BV, TLH20-18BV	\$76.89
Short Wear Liner		
426311	TLS20-18BV, TLH20-18BV	\$92.02
Wear Liner Kit		
462583	TLS20W-29BV, TLS20W-26EFI	\$289.95
Hose, Metal Galv. Interlock 8" Dia. x 60"		
484939-03	TL20W-29BV, TL20W-26EFI	\$178.38

## Call Us for Help on Truck Loader Parts 800 305 9255



## INQUIRE ABOUT PROSHIP

Pro-Ship is the best way to save money on shipping. Do you place orders frequently to replenish stock or need to keep inventory low? Get parts quickly at a low cost to you. ProShip is designed for anybody who needs to cut down costs but order all of the time

**PACKAGES START AT \$59.99**





# COMMERCIAL GRADE TRUCK LOADER HOSE

OUR HOSE WILL FITS THESE MAJOR BRANDS...AND MORE!



## Flexadux T-7W Truck Hose

Medium weight black thermoplastic rubber hose reinforced with a spring steel wire helix & yellow external polypropylene wearstrip.

Order Number	Inside Diameter	Length	Price Per
8901050000	5.00"	5" x 10'	\$79.99
8901060000	6.00"	6" x 10'	\$89.95
8901070000	7.00"	7" x 10'	\$99.95
8901080000	8.00"	8 x 10'	\$119.95
8901100000	10.00"	10" x 10'	\$169.95
8901120000	12.00"	12" x 10'	\$189.95

**affirm**  
**BUY NOW & PAY LATER**  
 PROPARTS DIRECT GIVES YOU THE OPTION TO BUY THE PARTS YOU NEED NOW AND PAY OVER TIME WITH AFFIRM. CHOOSE AFFIRM AT CHECKOUT TO APPLY FOR FIXED MONTHLY PAYMENT OPTIONS THAT FIT ANY BUDGET.  
\*SUBJECT TO ELIGIBILITY. PAYMENT OPTIONS THROUGH AFFIRM ARE PROVIDED BY THESE LENDING PARTNERS: AFFIRM.COM/LENDERS.



## Flex-Tube PV

Medium weight clear co-extruded PVC hose with a rigid black external PVC helix.

Order Number	Inside Diameter	Length	Price Per
3504040012	4.00"	4" x 12'	\$79.95
3504060012	6.00"	6" x 12'	\$119.95
3504060025	6.00"	6" x 25'	\$239.95
3504070012	7.00"	7" x 12'	\$149.95
3504070025	7.00"	7" x 25'	\$289.95
3504080012	8.00"	8" x 12'	\$179.95
3504080025	8.00"	8" x 25'	\$372.50
3504100012	10.00"	10" x 12'	\$224.89
3504100025	10.00"	10" x 25'	\$466.79
3504120012	12.00"	12" x 12'	\$279.95



## Bark Mulch Hose - Flex Tube PU

Medium weight clear co-extruded thermoplastic ether based polyurethane hose with a rigid yellow external ABS helix.

Order Number	Inner Diameter	Length	Price Per
3493040025	4.00"	4" x 25'	\$309.95
3493040050	4.00"	4" x 50'	\$539.30
3493040100	4.00"	4" x 100'	\$1,074.69
3493060006	6.00"	6" x 6ft	\$95.98
3493060012	6.00"	6" x 12 ft	\$191.49
3493080012	8.00"	12 ft	\$289.95
3493100012	10.00"	12 ft	\$339.00
3493120012	12.00"	12 ft	\$389.95



## Flexadux LCDC

Medium weight high performance black polypropylene blend hose reinforced with a spring steel wire helix & orange external polypropylene wearstrip.

Order Number	Inner Diameter	Length	Price Per
8871060010	6.00"	10 ft	\$74.95
8871070010	7.00"	10 ft	\$89.95
8871080010	8.00"	10 ft	\$99.95
8871100010	10.00"	10 ft	\$159.95
8871120010	12.00"	10 ft	\$169.95



## Flex-Thane HD

Heavy weight clear polyurethane hose reinforced with a bronze coated spring steel wire helix, Polyurethane Material.

Order Number	Inner Diameter	Length	Price Per
8391120010	12.00"	10 ft	\$408.95
8391140010	14.00"	10ft	\$504.78
8391160010	16.00"	10 ft	\$632.00
8391180010	18.00"	10 ft	\$730.00

Bridge Clamps for Flex-Tube®, PV, PU			Order Number	Description	Price Per
Order Number	Description	Price Per	02200700FT	7" Clamp	\$16.89
02200400FT	4" Clamp	\$14.95	02200800FT	8" Clamp	\$17.75
02200500FT	5" Clamp	\$14.95	02201000FT	10" Clamp	\$20.59
02200600FT	6" Clamp	\$16.00	02201200FT	12" Clamp	\$22.79

### T-7W Hose Bridge Clamps



Bridge Clamps are specially designed to fit between the coils on truck loader hose.

Order Number	Description	Price Per
02200400CW	4" Clamp	\$14.95
02200500CW	5" Clamp	\$14.95
02200600CW	6" Clamp	\$16.00
02200700CW	7" Clamp	\$16.89
02200800CW	8" Clamp	\$17.75
02201000CW	10" Clamp	\$20.59
02201200CW	12" Clamp	\$22.79

# Exmark Mower Blades

Shop from OEM and After-market Exmark blades



## Exmark Commercial 21 Series

Deck Size	Order Number	Price Each
21"	108-3759-S	\$23.49
30"	116-6358-03	\$21.89

@mowerman1s



## Exmark Turf Tracer S & X Series

Deck Size	Order Number	Price Each	3 or More
36" / 52"	103-6402-S	\$22.99	\$20.99
PROPARTS ALTERNATIVE	792-030	\$16.89	\$15.00
48"	103-6401-S	\$22.99	\$20.99
PROPARTS ALTERNATIVE	11231	\$14.88	\$13.29



## Exmark Metro ECS & Viking

Deck Size	Order Number	Price Each	3 or More
32" / 48"	103-6583-S	\$24.89	\$21.89
PROPARTS ALTERNATIVE	1009	\$16.89	\$15.00
36" / 52"	103-6584-S	\$24.89	\$21.89
PROPARTS ALTERNATIVE	3404	\$14.89	\$12.00



## Exmark Vantage Series

Deck Size	Order Number	Price Each	3 or More
36" / 52"	103-6402-S	\$22.99	\$20.99
PROPARTS ALTERNATIVE	792-030	\$16.49	\$15.00
48"	103-6401-S	\$22.99	\$20.99
PROPARTS ALTERNATIVE	11231	\$14.88	\$13.29
60"	103-6403-S	\$23.99	\$20.99
PROPARTS ALTERNATIVE	792-031	\$15.95	\$14.00



### Exmark Splined Blade Bushing

Used on Exmark Lazer Z Decks.  
For blades with .94 center diameter

Order Number :  
103-3037 Price .. \$19.99



## Exmark Lazer E, S & X Series

Deck Size	Order Number	Price	3 or More
48"	103-6401-S	\$22.99	
PROPARTS ALTERNATIVE	11231	\$14.88	\$13.29
52"	103-6402-S	\$22.99	\$20.99
PROPARTS ALTERNATIVE	792-030	\$16.49	\$15.00
60"	103-6403-S	\$23.99	\$20.99
PROPARTS ALTERNATIVE	792-031	\$15.95	\$14.00
72"	103-6404-S	\$31.99	\$28.00
PROPARTS ALTERNATIVE	792-033	\$19.95	\$18.00



## Exmark Quest E & S Series

Deck Size	Order Number	Price Each	3 or More
32" / 50"	115-5059-03	\$21.99	\$18.00
PROPARTS ALTERNATIVE	12273	\$15.88	\$14.00
Hi-Lift	131-3939-03	\$22.79	\$20.99
60"	115-9649-03	\$26.49	\$24.00

# Exmark Mower Blades

Shop from OEM and After-market Exmark Blades



**Exmark Navigator**

Deck Size	Order Number	Price	Shear Bolt / Nut	
42" LH	130-2860	\$24.89	Shear Bolt - 99-0283	
42" RH	130-2859	\$24.89	\$5.49 ea.	2 or More
48" LH	130-2861	\$22.58	Nut - 3296-42	\$20.59
48" RH	130-2862	\$22.58	\$0.48 ea.	\$20.59

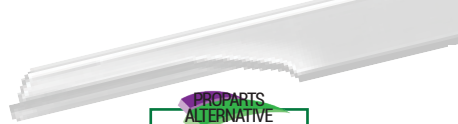

PROPARTS  
ALTERNATIVE  
P. PROPARTS  
A. APPROVED  
A. ALTERNATIVE  
P. PART



**Exmark Radius E, S & X Series**

Deck Size	Order Number	Price Each	2 or More
48"	103-6401-S	\$22.99	\$20.99
PROPARTS ALTERNATIVE	11231	\$14.88	\$13.29
52"	103-6402-S	\$22.99	\$20.99
PROPARTS ALTERNATIVE	1495	\$14.88	\$13.00
60"	103-6403-S	\$23.99	\$20.99
PROPARTS ALTERNATIVE	792-031	\$15.95	\$14.00

# Ferris Mower Blades

Shop from OEM and After-market Exmark Blades



**Ferris FW25**

Deck Size	Order Number	Price Each	2 or More
36"	5101756X2 (set)	\$44.99	
PROPARTS ALTERNATIVE	3404 (Single)	\$14.89	\$12.00
48"	5101986S (set)	\$59.99	
PROPARTS ALTERNATIVE	2172 (Single)	\$15.89	\$14.00
52"	5101756S (set)	\$49.95	
PROPARTS ALTERNATIVE	3404 (Single)	\$14.89	\$12.00



**Ferris FW35**

Deck Size	Order Number	Price Each	2 Or More
48"	5101986S (set)	\$59.99	
PROPARTS ALTERNATIVE	2172 (Single)	\$15.89	\$14.00
52"	5101756S (set)	\$49.95	
PROPARTS ALTERNATIVE	3404 (Single)	\$14.89	\$12.00
61"	5101755S (set)	\$68.99	
PROPARTS ALTERNATIVE	3434 (Single)	\$15.89	\$14.00



**Ferris F320Z**

Deck Size	Order Number	Price Each	2 Or More
61"	5101755S (set)	\$68.99	
PROPARTS ALTERNATIVE	3434 (Single)	\$15.49	\$14.00
72"	5102227S (set)	\$92.99	
PROPARTS ALTERNATIVE	16516 (Single)	\$20.89	\$18.00



**Ferris FX800X**

Deck Size	Order Number	Price Each	2 or More
61"	5101755S (set)	\$68.99	
PROPARTS ALTERNATIVE	3434	\$15.89	\$12.00
72"	5102227S (set)	\$92.99	
PROPARTS ALTERNATIVE	16516	\$20.89	\$18.00

# Ferris Mower Blades

Shop from OEM and After-market Ferris Blades

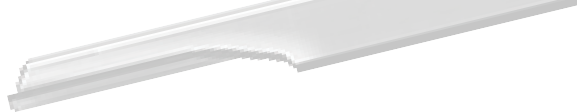

  
**P. PROPARTS**  
**A. APPROVED**  
**A. ALTERNATIVE**  
**P. PART**



**Ferris SRSZ1**

Deck Size	Order Number	Price Each	2 or More
36"	5101756X2 (set)	\$44.99	
<b>PROPARTS ALTERNATIVE</b>	3404 (Single)	\$14.89	\$12.00
48"	5101986S (set)	\$59.99	
<b>PROPARTS ALTERNATIVE</b>	2172 (Single)	\$14.89	\$14.00

**Ferris SRSZ2**

Deck Size	Order Number	Price Each	3 Or More
52"	5101756S (set)	\$49.95	
<b>PROPARTS ALTERNATIVE</b>	3404 (Single)	\$14.89	\$12.00
61"	5101755S (set)	\$68.99	
<b>PROPARTS ALTERNATIVE</b>	3434 (Single)	\$15.89	\$14.00



**Ferris SRSZ3X**

Deck Size	Order Number	Price Each	3 or More
61"	5101755S (set)	\$68.99	
<b>PROPARTS ALTERNATIVE</b>	3434	\$15.89	\$14.00
72"	5102227S (set)	\$92.99	
<b>PROPARTS ALTERNATIVE</b>	16516	\$20.89	\$18.00



**Ferris IS600Z**

Deck Size	Order Number	Price	3 or More
44"	5061827S (Set)	\$60.99	
48"	5101986S (set)	\$59.99	
<b>PROPARTS ALTERNATIVE</b>	2172 (Single)	\$15.89	\$14.00
52"	5101756S (set)	\$49.95	
<b>PROPARTS ALTERNATIVE</b>	3404 (Single)	\$14.89	\$12.00



**Ferris IS700Z**

Deck Size	Order Number	Price Each	3 or More
52"	5101756S (set)	\$49.95	
<b>PROPARTS ALTERNATIVE</b>	3404 (Single)	\$14.89	\$12.00
61"	5101755S (set)	\$68.99	
<b>PROPARTS ALTERNATIVE</b>	3434 (Single)	\$15.89	\$14.00



**Ferris IS2100Z**

Deck Size	Order Number	Price	3 or More
52"	5101756S (set)	\$62.99	
<b>PROPARTS ALTERNATIVE</b>	3404 (Single)	\$14.89	\$12.00
61"	5101755S (set)	\$68.99	
<b>PROPARTS ALTERNATIVE</b>	3434 (Single)	\$15.89	\$14.00

# Gravely Mower Blades

Shop from OEM and After-market Gravely Blades



**Gravely Pro-Turn 400**

Deck Size	Order Number	Sale Price	Alternative	Sale Price	3 or More
52"	00450300	\$23.95	3374	\$17.95	\$16.00
60"	09081200	\$24.95	13624	\$18.99	\$17.49
72"	04774600	\$31.95			



**Gravely Pro-Turn 100**

Deck Size	Order Number	Sale Price	Alternative	Sale Price	3 or More
48"	00450200	\$23.95	3400	\$17.95	\$16.00
52"	00450300	\$23.95	3404	\$14.89	\$12.00
60"	09081200	\$24.95	13624	\$18.99	\$17.49



**Gravely Pro-Walk Hydro**

Deck Size	Order Number	Sale Price	Alternative	Sale Price	3 or More
36"	00450300	\$23.95	3374	\$17.95	\$16.00
48"	00450200	\$23.95	3400	\$17.95	\$16.00
52"	00450300	\$23.95	3404	\$14.89	\$12.00
60"	09081200	\$24.95	13624	\$18.95	\$17.49



**Gravely ZTHD**

Deck Size	Order Number	Sale Price	Alternative	Sale Price	3 or More
44"	00450200	\$24.95	3400	\$17.95	\$16.00
48"	00450200	\$24.95	3400	\$17.95	\$16.00
52"	03253800	\$22.95	3404	\$14.89	\$12.00
60"	03253900	\$23.95	6180	\$15.89	\$14.00



**Gravely Pro-Turn 200**

Deck Size	Order Number	Sale Price	Alternative	Sale Price	3 or More
52"	00450300	\$23.95	3374	\$17.95	\$16.00
60"	09081200	\$24.95	13624	\$18.89	\$17.49
72"	04774600	\$30.95			



**Gravely Pro-Stance**

Deck Size	Order Number	Sale Price	Alternative	Sale Price	3 or More
36"	GPU10231	\$20.95	3404	\$14.89	\$12.00
48"	00450200	\$21.95	3400	\$17.95	\$16.00
52"	00450300	\$23.95	3404	\$14.89	\$12.00
60"	09081200	\$24.95	13624	\$18.99	\$17.49



**Gravely Pro-Turn, ZX, Z**

Deck Size	Order Number	Sale Price	Alternative	Sale Price	3 or More
48"	00450200	\$23.95	3400	\$17.95	\$16.00
52"	00450300	\$23.95	3404	\$14.89	\$12.00
60" ZX	03253900	\$26.95	13624	\$18.99	\$17.49
60"	09081200	\$26.95	13624	\$18.99	\$17.49



**Gravely ZTXL**

Deck Size	Order Number	Sale Price	Alternative	Sale Price	3 or More
42"	04769800	\$20.95	16161	\$14.95	\$13.00
52"	04771200	\$22.95	16289	\$14.95	\$12.00
60"	04965000	\$23.95			

# Scag Mower Blades

Shop from OEM and After-market Scag Blades

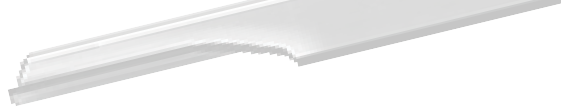

PROPARTS  
ALTERNATIVE

P. PROPARTS  
A. APPROVED  
A. ALTERNATIVE  
P. PART



## Scag SW Walk Behind

Deck Size	Order Number	Price	
32"	481706	\$17.80	
PROPARTS ALTERNATIVE	3403	\$14.89	
32"	Hi-Lift 481710	\$32.19	
PROPARTS ALTERNATIVE	6009	\$16.89	
36"	481707	\$18.29	3 Or More
PROPARTS ALTERNATIVE	3404	\$14.89	\$12.00
36"	Hi-Lift 481711	\$33.95	
PROPARTS ALTERNATIVE	3442	\$17.49	
48"	481706	\$17.80	
PROPARTS ALTERNATIVE	3403	\$14.89	
48"	Hi -Lift 481710	\$32.19	
PROPARTS ALTERNATIVE	6009	\$16.89	
52"	481707	\$18.29	3 or More
PROPARTS ALTERNATIVE	3404	\$14.89	12.00
52"	Hi-Lift 481711	\$33.95	
PROPARTS ALTERNATIVE	3442	\$15.95	

## Scag SWZ Hydro Walk Behind

Deck Size	Order Number	Price	3 or More
36"	481707	\$19.89	
PROPARTS ALTERNATIVE	3404	\$14.80	\$12.00
36"	Hi-Lift 481711	\$33.95	
PROPARTS ALTERNATIVE	3442	\$15.95	\$14.95
48"	481706	\$17.80	
PROPARTS ALTERNATIVE	3403	\$14.89	
48"	Hi -Lift 481710	\$32.19	
PROPARTS ALTERNATIVE	6009	\$16.89	
52"	481707	\$19.89	
PROPARTS ALTERNATIVE	3404	\$14.80	\$12.00
52"	Hi-Lift 481711	\$33.95	
PROPARTS ALTERNATIVE	3442	\$15.95	\$14.95
61"	481708	\$22.68	
PROPARTS ALTERNATIVE	3434	\$15.49	\$14.00
61"	Hi-Lift 481712	\$42.95	
PROPARTS ALTERNATIVE	10930	\$19.80	\$17.00



## Scag Patriot

Deck Size	Order Number	Price	3 or More
52"	482878	\$20.10	
PROPARTS ALTERNATIVE	3404	\$14.89	\$12.00
61"	482879	\$21.95	
PROPARTS ALTERNATIVE	3404	\$14.89	\$12.00



## Scag Freedom Z

Deck Size	Order Number	Price	3 Or More
48"	482877	\$19.98	
PROPARTS ALTERNATIVE	6009	\$16.89	
52"	482878	\$20.10	
PROPARTS ALTERNATIVE	3404	\$14.89	\$12.00

# Scag Mower Blades

Shop from OEM and After-market Scag Blades

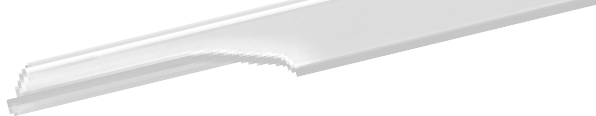

Scag Tiger Cat II

Deck Size	Order Number	Price	
48"	482877	\$19.98	
PROPARTS ALTERNATIVE	6009	\$16.89	
48"	Mulching Blade 483316	\$32.89	
PROPARTS ALTERNATIVE	6300	\$15.89	
52"	482878	\$20.10	3 or More
PROPARTS ALTERNATIVE	3404	\$14.89	\$12.00
52"	Mulching Blade 483317	\$31.49	
PROPARTS ALTERNATIVE	9229	\$19.49	\$18.00
61"	482879	\$21.95	
PROPARTS ALTERNATIVE	3434	\$15.49	\$14.00
61"	Mulching Blade 483318	\$32.20	
PROPARTS ALTERNATIVE	9230	\$18.49	\$17.50

PROPARTS ALTERNATIVE  
 P. PROPARTS  
 A. APPROVED  
 A. ALTERNATIVE  
 P. PART



Scag SVR-V Ride II

Deck Size	Order Number	Price	3 Or More
36	482878	\$20.10	
PROPARTS ALTERNATIVE	3404	\$14.89	\$12.00
36	Hi-Lift Blade 482879	\$21.95	
PROPARTS ALTERNATIVE	3434	\$15.49	\$14.00
48	482877	\$19.98	
PROPARTS ALTERNATIVE	6009	\$16.89	
48	Hi-Lift Blade 481710	\$32.19	
PROPARTS ALTERNATIVE	6009	\$16.89	
52	482878	\$20.10	
PROPARTS ALTERNATIVE	3404	\$14.89	\$12.00
52	Hi-Lift Blade 481711	\$33.95	
PROPARTS ALTERNATIVE	3442	\$15.95	\$14.95
61	482881	\$27.89	
PROPARTS ALTERNATIVE	3434	\$15.49	\$14.00
61	HI-Lift Blade 481712	\$39.80	
PROPARTS ALTERNATIVE	10930	\$19.80	



Scag Cheetah

Deck Size	Order Number	Price
48"	482877	\$19.89
PROPARTS ALTERNATIVE	6009	\$16.89
52"	482878	\$20.10
PROPARTS ALTERNATIVE	3404	\$14.89
61"	482881	\$27.89
PROPARTS ALTERNATIVE	3434	\$15.49
72"	482882	\$27.89
PROPARTS ALTERNATIVE	6026	\$19.98

### Fluid Film

- Protects against corrosion
- Will not harm paint
- Stops existing corrosion



Order Number  
15302  
Price  
\$12.99

## Blade Sharpening & Balancing Tools



### Precision Blade Balancer

Order number : 13216  
 Heavy duty precision blade balancer provides accurate blade balancing to increase the life of your mower and reduce vibrations, while providing a smoother cut.

**Sale Price: \$149.00**

### Blade Balancer

Order number : 42-100  
 Die-Cast balancer is perfect for quick blade balancing.

**Sale Price: \$5.89**



# Scag Mower Blades

Shop from OEM and After-market Scag Blades



Scag Liberty Z

Deck Size	Order Number	Price	3 Or More
36"	482878	\$20.10	
PROPARTS ALTERNATIVE	3404	\$14.89	\$12.00
48"	482877	\$19.98	
PROPARTS ALTERNATIVE	6009	\$16.89	
52"	482878	\$20.10	
PROPARTS ALTERNATIVE	3404	\$14.89	\$12.00

PROPARTS ALTERNATIVE  
 P. PROPARTS  
 A. APPROVED  
 A. ALTERNATIVE  
 P. PART



Scag Turf Tiger II

Deck Size	Order Number	Price	3 or More
52"	482878	\$20.10	
PROPARTS ALTERNATIVE	3404	\$14.89	\$12.00
61"	482879	\$21.95	
PROPARTS ALTERNATIVE	3434	\$15.49	\$14.00
61"	482881	\$27.89	
PROPARTS ALTERNATIVE	3434	\$15.49	\$14.00
72"	482882	\$27.89	
PROPARTS ALTERNATIVE	6026	\$19.98	

# Snapper Pro Mower Blades

Shop from OEM and After-market Snapper Blades



Snapper Pro SW25

Deck Size	Order Number	Price	3 or More
36"	5101756X2 (set)	\$44.59	
PROPARTS ALTERNATIVE	3404 (Single)	\$14.89	\$12.00
48"	5101986S (set)	\$59.99	
PROPARTS ALTERNATIVE	9009 (Single)	\$16.89	



Snapper Pro SW35

Deck Size	Order Number	Price	3 or More
48"	5101986S (Set)	\$59.99	
PROPARTS ALTERNATIVE	3403 (Single)	\$14.89	
52"	5101756S (Set)	\$49.95	
PROPARTS ALTERNATIVE	3404 (Single)	\$14.89	\$12.00
61"	5101755S (Set)	\$68.99	
PROPARTS ALTERNATIVE	3434 (Single)	\$15.49	\$12.00



Snapper Pro S125T

Deck Size	Order Number	Price	3 or More
52"	5101756S (set)	\$49.95	
PROPARTS ALTERNATIVE	3404 (Single)	\$14.89	\$12.00
61"	5101755S (set)	\$68.99	
PROPARTS ALTERNATIVE	3434 (Single)	\$15.49	\$14.00



Snapper Pro S150XT

Deck Size	Order Number	Price	3 or More
52"	5101756S (set)	\$49.95	
PROPARTS ALTERNATIVE	3404 (Single)	\$14.89	\$12.00



# Snapper Pro Mower Blades

Shop from OEM and After-market Snapper Blades



Snapper Pro S50XT

Deck Size	Order Number	Price	3 or More
36"	5101756X2 (set)	\$44.99	
PROPARTS ALTERNATIVE	3404 (Single)	\$14.89	\$12.00
48"	5101986S (set)	\$59.99	
PROPARTS ALTERNATIVE	3404 (Single)	\$14.89	\$12.00

PROPARTS ALTERNATIVE  
**P.** PROPARTS  
**A.** APPROVED  
**A.** ALTERNATIVE  
**P.** PART



Snapper Pro S200XT

Deck Size	Order Number	Price	3 or More
61"	5101755S (set)	\$68.99	
PROPARTS ALTERNATIVE	3434 (Single)	\$15.49	\$14.00
72"	5102227S (set)	\$92.99	
PROPARTS ALTERNATIVE	16516 (Single)	\$20.89	

# Toro Mower Blades

Shop from OEM and After-market Toro Blades



Toro Commercial 21

Deck Size	Order Number	Price	3 Or More
21"	125-1072-03	\$26.99	
30"	116-6358-03	\$21.89	\$18.00
PROPARTS ALTERNATIVE	14420 - FOR 30"	\$15.89	

PROPARTS ALTERNATIVE  
**P.** PROPARTS  
**A.** APPROVED  
**A.** ALTERNATIVE  
**P.** PART



Toro Grandstand

Deck Size	Order Number	Price
36"	105-7781-03	\$19.89
PROPARTS ALTERNATIVE	3404 (each)	\$14.89
48"	107-3194-03	\$23.98
52"	105-7781-03	\$19.89
PROPARTS ALTERNATIVE	3404 (each)	\$14.89
60"	105-7718-03	\$21.89
PROPARTS ALTERNATIVE	6083 (each)	\$14.89

## Mo-Deck

Allows for easier cleaning of mower deck. Stop grass from sticking to underside of deck.

## MODECK

**Price \$7.95**

**12 or more Price \$6.95 ea**



Toro Z-Master 6000 Series

Deck Size	Order Number	Price	3 or More
52"	105-7781-03	\$19.89	\$18.00
PROPARTS ALTERNATIVE	3404 (Single)	\$14.89	\$12.00
60"	105-7718-03	\$21.89	\$18.89
PROPARTS ALTERNATIVE	3083 (Single)	\$14.89	

**affirm**  
**BUY NOW & PAY LATER**  
 PROPARTS DIRECT GIVES YOU THE OPTION TO BUY THE PARTS YOU NEED NOW AND PAY OVER TIME WITH AFFIRM. CHOOSE AFFIRM AT CHECKOUT TO APPLY FOR FIXED MONTHLY PAYMENT OPTIONS THAT FIT ANY BUDGET.  
\*SUBJECT TO ELIGIBILITY. PAYMENT OPTIONS THROUGH AFFIRM ARE PROVIDED BY THESE LENDING PARTNERS AFFIRM.COM/LENDERS.

## Call us for Great Deals On Bulk Blade Orders!

Let our team of parts specialists put together the best bulk blade package deal for you, Give us a call and see what ProParts can do for you!  
**Call us at 800 305 9255**

# Toro Mower Blades

Shop from OEM and After-market Toro Blades



**PROPARTS  
ALTERNATIVE**  
P. PROPARTS  
A. APPROVED  
A. ALTERNATIVE  
P. PART



## Toro Z-Master 3000 Series

Deck Size	Order Number	Price	
48"	107-3192-03	\$19.89	
<b>PROPARTS ALTERNATIVE</b>	3403 (Single)	\$14.89	
52"	105-7781-03	\$19.89	<b>3 or more</b>
<b>PROPARTS ALTERNATIVE</b>	3404 (Single)	\$14.89	\$12.00
60"	105-7718-03	\$21.89	\$18.89
<b>PROPARTS ALTERNATIVE</b>	91-264 (Single)	\$14.89	
72"	105-7784-03	\$27.89	
<b>PROPARTS ALTERNATIVE</b>	791-627 (Single)	\$19.89	

## Toro Z-Master 5000 Series & Propane Units

Deck Size	Order Number	Price	
48"	107-3192-03	\$19.89	
<b>PROPARTS ALTERNATIVE</b>	3403 (each)	\$14.89	
52"	105-7781-03	\$19.89	<b>3 or More</b>
<b>PROPARTS ALTERNATIVE</b>	3404	\$14.89	\$12.00
60"	105-7718-03	\$21.89	\$18.89
<b>PROPARTS ALTERNATIVE</b>	91-264	\$14.89	
72"	105-7784-03	\$27.89	
<b>PROPARTS ALTERNATIVE</b>	791-627	\$19.89	



## Toro Z-Master 7000 Series

Deck Size	Order Number	Price	
52"	105-7781-03	\$19.89	<b>3 Or More</b>
<b>PROPARTS ALTERNATIVE</b>	3404	\$14.89	\$12.00
60"	105-7718-03	\$21.89	\$18.89
<b>PROPARTS ALTERNATIVE</b>	91-264	\$14.89	
72"	105-7784-03	\$27.89	
<b>PROPARTS ALTERNATIVE</b>	791-627	\$19.89	



## Toro 8000 Series Collector

Deck Size	Order Number	Price
42"	130-2859	\$24.89
42"	130-2860	\$24.89
48"	130-2862	\$23.89
48"	130-2861	\$23.89



**Toro Shear Pin**  
Used on Exmark Navigator & Toro 8000 series Zero-turns.  
**Order Number : 99-0283**  
**Price \$0.68 ea.**  
10 or more \$0.48 ea.

**Toro Shear Pin**  
Used on Exmark Navigator & Toro 8000 series Zero-turns.  
**Order Number : 99-0283**  
**Price . . \$5.89**  
10 or more \$5.49 ea.

# Wright Mower Blades

Shop from OEM and After-market Wright Blades



PROPARTS  
ALTERNATIVE

P. PROPARTS  
A. APPROVED  
A. ALTERNATIVE  
P. PART



## Wright Stand-On Mowers

Deck Size	Order Number	Price
32" / 48"	71440002	\$19.49
PROPARTS ALTERNATIVE	3403 (each)	\$14.89
Fusion Edge	71440008	\$20.95
PROPARTS ALTERNATIVE	15094	\$17.49
Mulching	71490001	\$23.95
PROPARTS ALTERNATIVE	14458	\$18.98
36" / 52"	71440001	\$20.95
PROPARTS ALTERNATIVE	3404	\$14.89
Fusion Edge	71440001	\$20.95
PROPARTS ALTERNATIVE	96-344	\$17.98
Mulching	71490002	\$23.95
PROPARTS ALTERNATIVE	6291	\$16.88
42" / 61"	71440003	\$22.95
PROPARTS ALTERNATIVE	3434	\$15.49
Fusion Edge	71440010	\$22.49
PROPARTS ALTERNATIVE	6272	\$19.89
Mulching	71490003	\$24.99
72"	71440014	\$26.95
PROPARTS ALTERNATIVE	791-627	\$19.89
Hardened Edge	96-341	\$25.95

## Wright Sport Mowers

Deck Size	Order Number	Price
32" / 48"	71440002	\$19.49
PROPARTS ALTERNATIVE	3403 (each)	\$14.89
Fusion Edge	71440008	\$20.95
PROPARTS ALTERNATIVE	15094	\$17.49
Mulching	71490001	\$23.95
PROPARTS ALTERNATIVE	14458	\$18.98
36" / 52"	71440001	\$20.95
PROPARTS ALTERNATIVE	3404	\$14.89
Fusion Edge	71440009	\$20.49
PROPARTS ALTERNATIVE	96-344	\$17.98
Mulching	71490002	\$23.49
PROPARTS ALTERNATIVE	6291	\$16.88
42" / 61"	71440003	\$22.95
PROPARTS ALTERNATIVE	3434	\$15.49
Fusion Edge	71440010	\$22.49
PROPARTS ALTERNATIVE	6272	\$19.89
Mulching	71490003	\$24.99



### Professional Deck Scraper

Designed for Any deck. Specifically designed for Commercial mower deck. Special curved blade is flexible and ergonomically designed.

Order number : GB2002  
**Sale Price: \$9.99**

# Wright Mower Blades

Shop from OEM and After-market Wright Blades



**PROPARTS  
ALTERNATIVE**  
P. PROPARTS  
A. APPROVED  
A. ALTERNATIVE  
P. PART



## Wright Walk-behind Mowers

Deck Size	Order Number	Price	
32" / 48"	71440002	\$19.49	3 or More
<b>PROPARTS ALTERNATIVE</b>	3403 (each)	\$14.89	\$12.00
Fusion Edge	71440008	\$20.95	
<b>PROPARTS ALTERNATIVE</b>	15094	\$17.49	
Mulching	71490001	\$23.95	
<b>PROPARTS ALTERNATIVE</b>	14458	\$18.98	
36" / 52"	71440001	\$20.95	
<b>PROPARTS ALTERNATIVE</b>	3404	\$14.89	\$12.00
Fusion Edge	71440001	\$20.95	
<b>PROPARTS ALTERNATIVE</b>	96-344	\$17.98	
Mulching	71490002	\$23.95	
<b>PROPARTS ALTERNATIVE</b>	6291	\$16.88	
42" / 61"	71440003	\$22.95	
<b>PROPARTS ALTERNATIVE</b>	3434	\$15.49	
Fusion Edge	71440010	\$22.49	
<b>PROPARTS ALTERNATIVE</b>	6272	\$19.89	
Mulching	71490003	\$24.99	

## Wright Mid-Mount Mowers

Deck Size	Order Number	Price	
32" / 48"	71440002	\$19.49	3 or More
<b>PROPARTS ALTERNATIVE</b>	3403 (each)	\$14.89	\$12.00
Fusion Edge	71440008	\$20.95	
<b>PROPARTS ALTERNATIVE</b>	15094	\$17.49	
Mulching	71490001	\$23.95	
<b>PROPARTS ALTERNATIVE</b>	14458	\$18.98	
36" / 52"	71440001	\$20.95	
<b>PROPARTS ALTERNATIVE</b>	3404	\$14.89	\$12.00
Fusion Edge	71440009	\$20.49	
<b>PROPARTS ALTERNATIVE</b>	96-344	\$17.98	
Mulching	71490002	\$23.49	
<b>PROPARTS ALTERNATIVE</b>	6291	\$16.88	
42" / 61"	71440003	\$22.95	
<b>PROPARTS ALTERNATIVE</b>	3434	\$15.49	
Fusion Edge	71440010	\$22.49	
<b>PROPARTS ALTERNATIVE</b>	6272	\$19.89	
Mulching	71490003	\$24.99	

### Blade Balancer

Order number : 42-100

Die-Cast balancer is perfect for quick blade balancing.

**Sale Price: \$5.89**



### Mo-Deck

Allows for easier cleaning of mower deck.

Order Number :  
MODECK

**Price . . \$7.95**  
**12 or more \$6.95 ea.**



### Fluid Film

- Protects against corrosion
- Will not harm paint
- Stops existing corrosion

Order Number :  
15302  
**Price . . \$12.99**



# Walker Mower Blades

Shop from OEM and After-market Walker Blades



## Collection Decks

Deck Size	Order Number LH	Order Number RH	Price
DC36	5705-2	5705-0	\$30.29
Blade Hub Set 36" Includes Hubs and shear pins		5705-6	\$110.39
DC36R	5705-35	5705-36	\$24.60
DC42	5705-3	5705-4	\$32.36
Blade Hub Set 42" Includes Hubs and Shear pins		5705-8	\$129.79
DC42R	5705-4	5705-3	\$32.36
DC48	7705-1	7705-2	\$34.00
DGHS48R	7705-2	7705-1	\$34.00
Blade hub Set 48" Includes Hubs and Shear pins		7705-3	\$124.89
DC52R	7705-35	7705-34	\$35.85
Blade Hub Set 52" Includes Hubs and Shear pins		7705-41	\$127.79

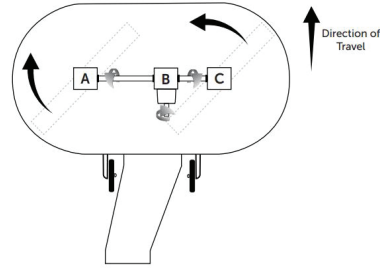

Collection Deck Standard Rotation

**Walker DGHS48 Deck**

Original Deck Shell. Includes decals, rubber mats  
Replaces 7701, 7702-17  
**Order Number: 7702-20**  
**Price: \$1,461.22**

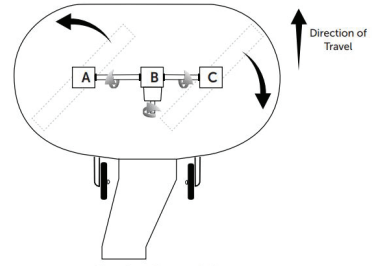

Collection Deck Reverse Rotation

## Side / Rear Discharge Decks

Deck Size	Order Number LH	Order Number RH	Price
DSD36	5705-1	5705-1	\$28.78
Blade Hub Set 36"		5705-5	\$114.76
DSD42	5705-3	5705-3	\$32.36
Blade Hub Set 42"		5705-7	\$116.74
DSD48	7705-1	7705-1	\$34.00
DSD52 (3)	5705-14	5705-14	\$27.99
DSD56 (3)	5705-0	5705-0	\$30.29

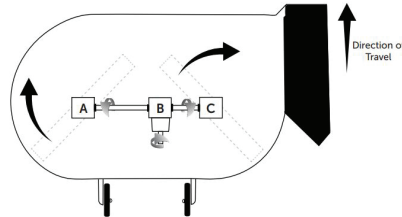

Side Discharge Deck Rotation

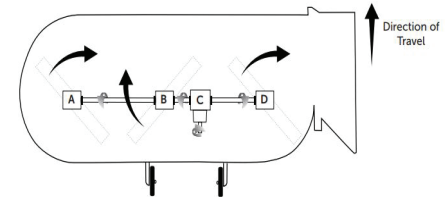

3 Blade Side Discharge Deck Rotation

## Mulching Decks

Deck Size	Order Number LH	Order Number RH	Price
DML36	5705-23	5705-23	\$24.95
DML42A	5705-28	5705-28	\$27.10
DML42B	5705-11	5705-11	\$32.39
DML48	Mulch Blade kit with Hubs 7705-45		\$223.65

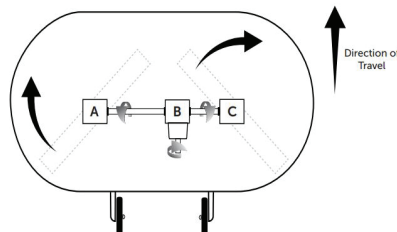

Mulching Deck Rotation

### Walker Sheer Pins

Original Walker Mower Blade Sheer Pin  
Size: 10-24 x 5/8 SHC Screw  
**Order Number: F202**  
**Sale Price: \$0.99**  
**10 or more \$0.88 ea.**

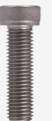

Original Walker Mower Blade Keps Nut  
Size: 10-24 Lock Nut  
**Order Number: F002**  
**Sale Price: \$0.49 ea.**  
**10 or more \$0.39 ea.**





**NEW  
ITEM  
14 Gal.**

## Gas Caddy

The Flo n' Go 6792 Duramax 14 gal. Gas Caddy is a safe, fast, and convenient way to refill gas-powered tools, lawn tractors, boat engines, generators, snowmobiles, ATVs, etc. The patented gas pump handle allows you to eliminate spillage and overfills by stopping and restarting the flow of gas. Stand the Duramax gas can vertically when refueling gas-powered engines. The fuel caddy has a flow rate of 2 gallons per minute in siphon mode (gravity flow).

- Durable polyethylene gas caddy is resistant to corrosion and dents
- Heavy-duty 6 in. wheels make the fuel caddy easy to transport
- Gas caddy includes a 10 ft. long fuel hose
- Bolt-on hanger for convenient fuel line storage
- Caddy dimensions: 16.2 L x 12.7 W x 33.8 H

**Order Number: 6792**  
**Price . . \$139.99**

**affirm**  
**BUY NOW & PAY LATER**  
PROPARTS DIRECT GIVES YOU THE OPTION TO BUY THE PARTS YOU NEED NOW AND PAY OVER TIME WITH AFFIRM. CHOOSE AFFIRM AT CHECKOUT TO APPLY FOR FIXED MONTHLY PAYMENT OPTIONS THAT FIT ANY BUDGET.  
 \*SUBJECT TO ELIGIBILITY. PAYMENT OPTIONS THROUGH AFFIRM ARE PROVIDED BY THESE LENDING PARTNERS: AFFIRM.COM/LENDERS.

## NO-SPILL® gas can. The only spill-proof, DOT approved gas can!

### 1.25 Gallon No-Spill Can

1.25 Gal. Fuel Can

Order Number :  
1415

**Price . . \$19.49**



### 5 Gallon No-Spill Diesel Can

5 Gal. Fuel Can  
Handle on Rear

Order Number :  
1457

**Price . . \$39.95**



### 5 Gallon No-Spill Kerosene Can

5 Gal. Fuel Can  
Handle on Rear

Order Number :  
1456

**Price . . \$39.95**



### 2.5 Gallon No-Spill Can

2.5 Gal. Fuel Can

Order Number :  
1405

**Price . . \$22.89**



### 5 Gallon No-Spill Can

5 Gal. Fuel Can  
Handle on Rear

Order Number :  
1450

**Price . . \$39.95**



### Replacement Gas Cap

Order Number:  
6132

**Price . . \$11.95**



### 6" Flexible Spout

Order Number:  
0206

**Price . . \$4.59**



## Kinetix Spill Absorbent Shop Rolls

Contains 20 15" x 60" Sheets

**Order Number: L71320PS**  
**Sale Price: \$23.20**

Engineered to rapidly absorb water, oil, gasoline and diesel fuels, coolants, solvents and all sorts of petroleum and water-based fluids, Kinetix® industrial-grade spill containment products effectively control liquid spills common in the garage, the shop and on the factory floor.



## SRM ECHOMATIC Trimmer Head

A bump-to-advance feed line system designed for light to medium trimming

Fits SRM Models

Accepts 20' of .095 in. line

Maximum line diameter of .105 in.

Order Number 21560070

**Price: \$19.89**



## Maxi-Cut & Pro Maxi Cut

3 Serrated-edge polymer blades for heavy grasses

Use when traditional line will not work

Order Number 215511 - (Pro Maxi-Cut)

**Price: \$21.99**



**Maxi-Cut**  
Pack of 12 Blade  
Order Number: 215712  
**Price: \$10.99**



# VORTEX TRIMMER LINE

## COPPERHEAD®

### Features & Benefits

- Less drag
- Longer wear
- Significant improvement in energy efficiency
- Up to 50% noise reduction in larger diameter lines
- Patented design
- Increased RPMs allows use of larger diameter lines
- More impact power
- Superior tensile strength
- Decreased vibration
- Twisted, Aerodynamic Design

*Want Those  
CRISPY EDGES?*



Order Number	Line Size	Price	2 or More Each
12174	.080	\$39.95	\$34.95
12175	.095	\$39.95	\$34.95
12176	.105	\$39.95	\$34.95
12177	.130	\$39.95	\$34.95
12178	.155	\$39.95	\$34.95
12179	.095	\$54.95	\$50.95
12180	.105	\$54.95	\$50.95
12181	.130	\$54.95	\$50.95
12182	.155	\$54.95	\$50.95



### Trimmer Line Cutter

Line cutter simple & safe to use.

Fits on key ring.  
Cuts line from .056 to .130

Order Number  
12820 **\$3.95 ea**



### Trailer Spool Holder

Neatly stores trimmer line out of the way, tension on the spool prevents line from unwinding until you need it. Easily installs on Open and Enclosed Trailers Can Hold 3lb. or 5lb. Spools Hammered paint finish

**Order Number: RA-2**  
**PRICE: \$35.49**



## Black Diamond Line

Razor Sharp Edges - Designed for 1-pass Cutting  
Twisted Geometry - Decreases Drag, Higher RPM  
Optimizes Fuel Consumption  
Durable Design Proven to hold up against hard surfaces

**Our  
Toughest  
line!**



Order Number	Line Size	Weight	Sale Price
330095073	.095	885 ft	\$39.95 ea.
330095075	.095	1394 ft	\$68.95 ea.

## STIHL AUTO-CUT 25-2 Replacement Trimmer Head

2 or more  
**\$19.88**  
Each



Order Number: 14073  
Price \$26.<sup>95</sup> ea.

Fits Stihl Trimmers FS80, FS81, FS83, FS85, FS86, FS88, FS90, FS91, FS96, FS100, FS106, FS108, FS110, FS120, FS130, FS200, FS250, FS350, FS450, FS500

### Replacement Parts for Spool

Order Number	Item	Price
14501	Cover	\$11.05
15152	Spring	\$1.80
15151	Eyelet	\$1.24
14500	Spool	\$6.55

## Trailer Spool Holder

Neatly stores trimmer line out of the way, tension on the spool prevents line from unwinding until you need it. Easily installs on Open and Enclosed Trailers Can Hold 3lb. or 5lb. Spools Hammered paint finish



Order Number: RA-2  
PRICE: \$35.49

## Trimmer Line Cutter

Line cutter simple & safe to use.

Fits on key ring.  
Cuts line from .056 to .130

Order Number  
12820 \$3.95 ea



Buy 2  
For  
**\$3.49 ea.**

## Cross Fire Line

Razor Sharp Edges - Designed for 1-pass Cutting  
Twisted Geometry - Decreases Drag, Higher RPM  
Optimizes Fuel Consumption  
Durable Design Proven to hold up against hard surfaces



Order Number	Line Size	Weight	Sale Price
314095053	.095	3 lbs	\$39.89 ea.
316095053	.095	5 lbs	\$54.99 ea.

## Round Line

Round line feeds easier through the trimmer head. Trimmer line can be used in all trimmers.



Order Number	Line Size	Weight	Sale Price
313095053	.095	3 lbs	\$36.95 ea.
315095053	.095	5 lbs	\$48.59 ea.

## Round Gator Line

Gator Round Line quickly and easily cuts through low grass and grass-like weeds yet is durable enough to tackle sizable brush without breaking. This trimmer line is less likely to bond together in the trimmer head due to its weld-resistant outer layer.



Great for  
Walkway  
Edging

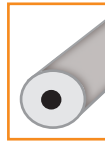

Order Number	Line Size	Weight	Sale Price
22-195	.095	3 lb	\$39.95
22-595	.095	5 lb	\$59.95
22-105	.105	3 lb	\$49.95
22-505	.105	5 lb	\$69.95

## Oregon Gator Line

Razor Sharp Edges - Designed for 1-pass Cutting  
Twisted Geometry - Decreases Drag, Higher RPM  
Optimizes Fuel Consumption  
Durable Design Proven to hold up against hard surfaces

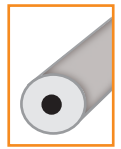

Order Number	Line Size	Weight	Sale Price
Gatorline			
21-595	.095	5 lb	\$59.95

## Square Gator Line

Oregon Magnum Gatorline square string trimmer line incorporates a high-strength inner core with a weld-resistant outer layer for long-lasting characteristics. Fits all standard trimmer heads.

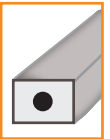

Order Number	Line Size	Weight	Sale Price
22-895	.095	3 lb	\$39.95
22-095	.095	5 lb	\$59.95

## Platinum Gator Line

Platinum Gatorline Trimmer line is great for professionals because it is better at resisting breakage than standard trimmer line. Plus, it offers outstanding durability and shock absorbency thanks to its highly flexible core. This trimmer line is low noise, which means it produces fewer decibels of noise when it spins, helping you comply with local noise ordinances.



Order Number	Line Size	Weight	Sale Price
Platinum Gatorline			
20-102	.095	5 lb	\$44.95
20-113	.095	3 lb	\$59.95
20-103	.105	3 lb	\$59.95
20-114	.105	5 lb	\$89.49





**Echo Air Filter**  
Fits GT, SRM, HC, PAS & PE models.  
Order Number: A226001410  
**Price \$6.26**  
10 or more \$5.26 ea



**Echo Air Filter**  
Fits PB403, PB403H, PB403T, PB413H, PB413T, PB500H, PB500T, PB603, PB611, PB620, PB620ST, PB650, PB650H, PB650T, PB651T  
Order Number: A226000032  
**Price \$9.47**



**Echo Air Filter**  
Fits EB-633 PB-60H PB-460 PB-600 PB-601 PB-750 PB-755, EB633  
Order Number: 13030508361  
**Price \$12.09**

**PB-9010  
TUNE UP KIT  
Price \$36.<sup>29</sup>**

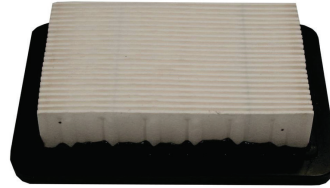

**Shindaiwa Air Filter**  
Fits Shindaiwa EB-802, EB-802RT, EB854, EB854RT  
Order Number: A226000531  
**Price \$23.80**

**Alternative for RedMax Filters**

**Filter Replaces 54471501**  
Order Number: 9909  
**\$11.89 ea.**  
**Filter Replaces 544271601**  
Order Number: 10311  
**\$7.89 ea.**



**Redmax Air Filter**  
Fits Redmax EB7000 & EB8000 Series Blowers.  
Length: 7 3/4", Height: 13/16", Width: 5 3/32"  
Order Number: 544271501  
**Price \$24.89**



**Redmax Pre-Filter**  
Fits Redmax EB7000 & EB8000 Series Blowers.  
Order Number: 544271601  
**Price \$14.99**

**REPLACEMENT FUEL FILTERS**



Order Number: 12952  
**Price \$3.20**  
Bag of 10+ \$2.88 ea



Order Number: 12949  
**Price \$3.49**  
Bag of 10+ \$3.14 ea



Order Number: 12619  
**Price \$5.95**  
Bag of 10+ \$4.95 ea



Order Number: 07 210  
**Price \$5.47**  
Bag of 10+ \$4.93 ea



Order Number: 07 217  
Fits most trimmers  
Replaces Stihl 000-350-3502  
**Price \$6.50**  
10 For \$5.85 ea.



Order Number: 25 050 42-S  
**Price \$10.99**  
Fits Kohler ECH630-ECH749, ECV630-ECV749



Order Number: 07 109  
2332" OD x 1-3/4" Length  
Replaces Stihl 0000-350-3500  
**Price \$7.58**  
10 For \$6.83 ea.



Order Number: 9025  
Replaces Walbro 125-528  
**Price \$4.09**  
10 For \$3.69 ea.



Order Number: 07 208  
**Price \$3.49**  
For 3/16" fuel line  
10 or more \$3.15 ea



Order Number: 9024  
**Price \$3.29**  
10 For \$2.97 ea.  
Replaces Walbro 1-25-527-01

**Fuel Line Remover Tool**



This tool is handy for prying fuel line off of the barbed end of a fitting. this tool is hardened and plated to ensure long life. Remove Fuel clamps before use, leverage tool against engine components.

Order Number: 19620  
**Price \$38.88**



**Shop Pack of 24 Plugs  
Champion OEM Spark Plugs**

Order Number	Plug Number	Service Pack Cost
322S	RN11YC	\$49.99
431S	RC14YC	\$59.99
71S	RC12YC	\$59.99
841S	J8C	\$59.99
843S	CJ8	\$50.95
845S	J17LM	\$59.99

Order Number	Plug Number	Service Pack Cost
847S	DJ8J	\$59.99
848S	CJ8Y	\$59.99
853S	CJ7Y	\$59.99
861S	J19LM	\$50.95
868S	RJ19LM	\$69.99
852S	RCJ6Y	\$69.99



All service/shop packs supplies in packages of 24

+Use the assigned part numbers to get these special shop pack prices when ordering

# Kawasaki

## ENGINES

### QUALITY TO THE CORE

Designed for optimum oil flow, pressure, and protection in extreme conditions and high heat.



Kawasaki filters are specifically engineered for optimum flow pressure and protection in constant speed air-cooled and liquid cooled engines.

**Kawasaki Oil Filter**  
For Kawasaki FD, FE, FH, FJ180V and FX engines  
Replaces 49065 7010



Order Number:  
49065 0724

Price . . . \$9.49 ea.

12 or more

PRICE . . . \$8.49 ea.

**Kawasaki Oil Filter**  
For Kawasaki FX and FJ engines; HT 2-3/8"  
Replaces 49065 7007



Order Number:  
49065 0721

Price . . . \$9.49 ea.

12 or more

PRICE . . . \$8.49 ea.

## Kawasaki Donaldson Canister Air Filter



**Fits FX651V - FX1000V Internal Vented Carb**

Order Number	Each
11013-7044	\$24.95
11013-7045	\$22.89

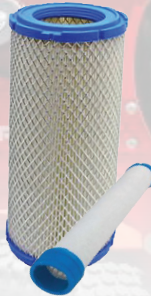

**Fits Kawasaki FH601D- FH721V, FH770D, FD750D, FD791D**

Order Number	Each
11013-7020	\$24.98
11013-7019	\$27.70

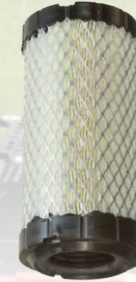

**Fits Kawasaki FH451V - FH580V (Small Canister Filter)**

Order Number	Price Each
11013-7029	\$18.57

### Fuel Filters



Most carbureted air cooled engines

Order Number	Price Each
49019-0027	\$7.89



All F730V EFI and 850V EFI Engines

Order Number	Price Each
49019-0031	\$6.95



Fits Kawasaki FD Engines

Order Number	Price Each
49019-0032	\$21.98



**Fits Kawasaki FT730V (Small Canister Filter)**

Order Number	Price Each
11013-0763	\$23.09
11013-0764 (Pre)	\$7.83

### Need a Kawasaki Engine?

Contact us with your model and spec number and we can locate the right engine for you.

Need to Repower? Switch From a Kohler or Briggs engine?

**CALL 800 305 9255**

Scan the QR Code to browse the 2024 Kawasaki engine brochure.



#### PRO TIP:

Your Model and Spec are located on a tag on the side of the engine cowl.

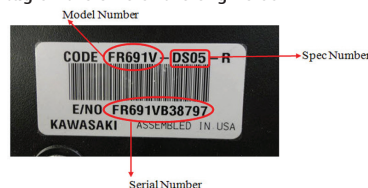

**Fits Kawasaki FX481V, FS41V - FX600V (Small Canister)**

Order Number	Price Each
11013-7048	\$24.49

**Fits Kawasaki FR651V - FR730V & FS481V - FS730V**

Includes Pre-Filter  
Was 99999-0384



Order Number	Price Each
11029-0031	\$17.86

#### Oil Filter Wrench

Fits 2-1/2" to 4-1/2" Oil Filters, 20 Degree Jaw Angle.

Teeth provide non-slip grip

Order Number: 752-836

**Price: \$29.89**

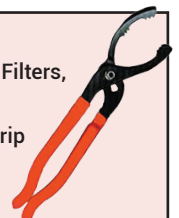

**Kawasaki K-Tech 4-Cycle Oil** is enhanced with Anti-foaming and anti-shear agents, along with other special additives. K-Tech 4-cycle oil also contains Zinc which helps reduce camshaft wear.



**Kawasaki**  
— ENGINES —  
GENUINE PARTS

**Kawasaki K-Tech 4-Cycle Oil 5 Quart Bottles Now In-Stock!**

Order Number	Description	Each	Price Per Case (12)	
99969-6281	SAE 30 (1 Qt.)	\$7.49	(\$6.09 ea.)	\$73.08
99969-6081	10W-30 (1 Qt.)	\$7.49	(\$6.09 ea.)	\$73.08
99969-6296	10W-40 (1 Qt.)	\$7.49	(\$6.09 ea.)	\$73.08
99969-6501	15W-50 Synthetic	\$8.98	(\$8.49 ea.)	\$104.88
99969-6298	20W-50 (1 Qt.)	\$8.98	(\$6.69 ea.)	\$80.28

Order Number	Description	Each	3 Or More
99969-6502	15W-30 (5 Qt.)	\$49.95	\$44.59 ea.
99969-6504	20W-50 (5 Qt.)	\$49.95	\$44.59 ea.

**Fits Kawasaki FR541V - FR600V**



Was 99999-0383

Order Number	Price Each
11013-0727	\$11.85

**Fits FH381V-FH580V KAI Engines**



Order Number	Price Each
11013-7031	\$22.89
11013-7025	\$5.83

Pre-Filter Kawasaki 11013-7025

**Fits Kawasaki FH451V - FH580V**

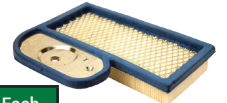

Non KAI Engine

Order Number	Price Each
11013-7002	\$18.42
11013-7033	\$5.25

Pre-Filter Kawasaki 11013-7002

**Fits Kawasaki FH381/FH430 Non-KAI Engine**



Order Number	Price Each
11013-7017	\$16.46
11013-7034	\$6.39

Pre-Filter Kawasaki 11013-7034

**Fits Kawasaki FH601V - FH721V**

Internally Vented Carb W / Pre-Filter



Order Number	Price Each
11029-7015	\$26.47

**Fits FJ180V KAI Engines**

(Previously 11029-0019)



Order Number	Price Each
11029-0049	\$24.49

**Fits FJ180V Most M & S Series**



Order Number	Price Each
11013-2232	\$4.38

**Fits FJ180V M Series**

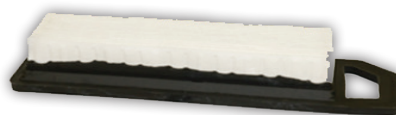

Order Number	Price Each
11029-0018	\$13.70

**Fits FJ180V S Series**



Order Number	Price Each
11029-0017	\$11.20

**Kawasaki FS, FX Electric Starter**

FITS MODELS - Kawasaki: FS541V-AS30, FS600V-CS24, FS600V-DS24, FS730V-AS19, FX481V-BS09, FX541V-DS05, FX541V-ES00, FX600V-DS05, FX600V-DS11, FX600V-ES00, FX600V-ES02, FX600V-FS09, FX651V-ES00, FS691V-AS24, FS691V-AS26, FS691V-AS28, FS691V-ES00, FX730V-AS29, FX730V-AS31, FX730V-AS40, FX730V-ES00.

12-Volt Starter.

Replaces 21163-0756



**SAVE \$30**  
Regular \$269.95

Order Number	Price Each
99996-6120	\$239.95

**Kawasaki Flexible Oil Drain Hose**



Length: 16"  
Dia: 3/4"

Hi-temperature, heavy duty braided rubber hose. Designed for durability and longevity. Pressure tolerance: 400 psi. Durable all brass fittings. For use on all Kawasaki Engines. Fittings convert to SAE wrench sizes.

Order Number	Price Each
51044-0902	\$34.95

# Kawasaki

— ENGINES —

## Tune-Up Kits Give You The Complete Set-Up To Keep Your Engine Running Its Best.

Stay Warranty Compliant with OEM Kawasaki Parts



### FX 1000V, 921V Engines

Kit Contains: 2 Bottles of Oil, 1 Oil Filter, 1 Fuel Filter, 1 Inner Air Filter, 1 Out Air Filter, 2 Spark Plugs

Order Number	OIL
99969-6529	10W-40
99969-6530	20W-50
<b>YOUR CHOICE SALE PRICE</b>	<b>\$119.95</b>



### FX 730V, 691V, 651V Carbureted & EFI

Kit Contains: 2 Bottles of Oil, 1 Oil Filter, 1 Fuel Filter, 1 Inner Air Filter, 1 Out Air Filter, 2 Spark Plugs

Order Number	OIL
99969-6527	10W-40
99969-6528	20W-50
<b>YOUR CHOICE SALE PRICE</b>	<b>\$119.95</b>



### FT 730V EFI

Kit Contains: 2 Bottles of Oil, 1 Oil Filter, 1 Fuel Filter, 1 Inner Air Filter, 1 Out Air Filter, 2 Spark Plugs

Order Number	OIL
99969-6545	10W-40
99969-6546	20W-50
<b>YOUR CHOICE SALE PRICE</b>	<b>\$109.95</b>



### FT 730V, 691V, 651V Carbureted

Kit Contains: 2 Bottles of Oil, 1 Oil Filter, 1 Fuel Filter, 1 Inner Air Filter, 1 Out Air Filter, 2 Spark Plugs

Order Number	OIL
99969-6569	10W-40
99969-6570	20W-50
<b>YOUR CHOICE SALE PRICE</b>	<b>\$99.95</b>



### FH 770D KAI, 721V, 680V, 661V, 641V, 601V

Kit Contains: 2 Bottles of Oil, 1 Oil Filter, 1 Fuel Filter, 1 Inner Air Filter, 1 Out Air Filter, 2 Spark Plugs

Order Number	OIL
99969-6531	10W-40
99969-6532	20W-50
<b>YOUR CHOICE SALE PRICE</b>	<b>\$120.95</b>



### FH 580V, 541V, 531V, 500V, 451V Standard Air Filter

Kit Contains: 2 Bottles of Oil, 1 Oil Filter, 1 Fuel Filter, 1 Inner Air Filter, 1 Out Air Filter, 2 Spark Plugs

Order Number	OIL
99969-6535A	10W-40
99969-6536A	20W-50
<b>YOUR CHOICE SALE PRICE</b>	<b>\$89.95</b>

# Kawasaki

— ENGINES —

## Tune-Up Kits Give You The Complete Set-Up To Keep Your Engine Running Its Best.

Stay Warranty Compliant with OEM Kawasaki Parts



**FR 730V, 691V, 651V, All FS Series Carbureted & EFI**  
 Kit Contains: 2 Bottles of Oil, 1 Oil Filter, 1 Fuel Filter, 1 Inner Air Filter, 1 Out Air Filter, 2 Spark Plugs

Order Number	OIL
99969-6543	10W-40
99969-6544	20W-50
<b>YOUR CHOICE SALE PRICE</b>	<b>\$89.95</b>



**FX 850V, 801V, 751V Carbureted & EFI**  
 Kit Contains: 2 Bottles of Oil, 1 Oil Filter, 1 Fuel Filter, 1 Inner Air Filter, 1 Out Air Filter, 2 Spark Plugs

Order Number	OIL
99969-6537	10W-40
99969-6538	20W-50
<b>YOUR CHOICE SALE PRICE</b>	<b>\$120.00</b>



**FX600V, 541V, 481V**  
 Kit Contains: 2 Bottles of Oil, 1 Oil Filter, 1 Fuel Filter, 1 Inner Air Filter, 1 Out Air Filter, 2 Spark Plugs

Order Number	OIL
99969-6539	10W-40
99969-6540	20W-50
<b>YOUR CHOICE SALE PRICE</b>	<b>\$99.95</b>



**FH 580V, 541V, 480V, 430V, 381V All KAI**  
 Kit Contains: 2 Bottles of Oil, 1 Oil Filter, 1 Fuel Filter, 1 Inner Air Filter, 1 Out Air Filter, 2 Spark Plugs

Order Number	OIL
99969-6533A	10W-40
99969-6534A	20W-50
<b>YOUR CHOICE SALE PRICE</b>	<b>\$99.95</b>



**FH 721V, 680V, 661V, 641V, 601V All with Standard Air Filter**  
 Kit Contains: 2 Bottles of Oil, 1 Oil Filter, 1 Fuel Filter, 1 Inner Air Filter, 1 Out Air Filter, 2 Spark Plugs

Order Number	OIL
99969-6525*	10W-40
99969-6526*	20W-50
<b>YOUR CHOICE SALE PRICE</b>	<b>\$99.95</b>



**FR 600V, 541V**  
 Kit Contains: 2 Bottles of Oil, 1 Oil Filter, 1 Fuel Filter, 1 Inner Air Filter, 1 Out Air Filter, 2 Spark Plugs

Order Number	OIL
99969-6541	10W-40
99969-6542	20W-50
<b>YOUR CHOICE SALE PRICE</b>	<b>\$79.95</b>

\* KIT 99969-6525/99969-6526 IS FOR ENGINES WITH INTERNALLY VENTED CARBURETORS ONLY

# KOHLER® Engines

Unlike standard engine oils, KOHLER genuine oils are specifically formulated for KOHLER engines. KOHLER oils are specially blended with heavy duty, high-temperature additives providing outstanding protection.



## Kohler SAE 30

Recommended for high-temperature operations and heavy-duty service

Order Number :

25 357 02-S

Price . . \$8.29 Qt.

12 or more \$7.39 ea.



## Kohler 15W-40

Provides improved wear protection, deposit and oil consumption control

Order Number :

25 357 48-S

Price . . \$8.59 Qt.

12 or more \$7.69 ea.



## Kohler 10W-30

Protects in a broad range of operating temp. Easier cold weather starting

Order Number :

25 357 64-S

Price . . \$7.59 Qt.

12 or more \$6.89 ea.



## Kohler 20W-50

Ideal for heavy-duty service. Ideal for CH940 to CH1000, CV940 - CV1000

Order Number :

25 357 67-S

Price . . \$8.98 Qt.

12 or more \$7.49 ea.



## Kohler 10W-40

Great for generators powered by gas fueled engines with flat tappet lifters

Order Number :

25 357 70-S

Price . . \$7.89 Qt.

12 or more \$6.89 ea.

## Kohler Oil Filter

Short Kohler Filter

Fits Command, Command Pro

Order Number:

12 050 01S

Price . . . . . \$8.49 ea.

12 or more . . \$6.29 ea.



## Kohler Oil Filter

Tall Kohler Filter

Fits Command, Command Pro

Order Number:

52 050 02S

Price . . . . . \$8.49 ea.

12 or more . . \$6.29 ea.

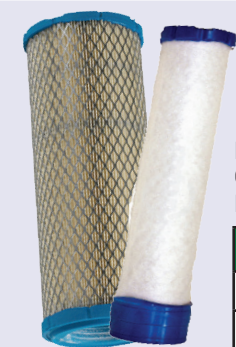

Buy 2 or More  
25-083-01-S  
\$20.90 ea.

# Kohler Donaldson Canister

Fits CH18-CH26, CH620-CH1000, CV17-CV26, CV620, CV1000, LH630-LH775, EFI ECH630-ECH749, ECV630-ECV749

Order Number	Each	
25 083 01-S	\$23.90	10 or More
25 083 04-S	\$20.95	\$19.00 ea.

Fits Command Pro CV460-CV493, OHC, TH16, TH18, TH520, TH575

Order Number	Each	
25 083 02-S	\$21.95	10 or More
25 083 03-S	\$20.95	\$19.00 ea.

Buy 2 or More  
25-083-03-S  
\$18.95 ea.



## Kohler OEM Air Filters

### Fits Command Pro CH395, CH440

Pre-filter Included



Order Number	Your Price Each
17 883 03-S1	\$20.49

### Fits Command and EFI CH18-CH25, CH620-CH740, CV17-CV23, CV620-CV670, ECH630-ECH749, ECV630-ECV749



Pre-filter Included

Order Number	Your Price
24 883 03-S1	\$20.99

### Fits 3000 Series SH265

Pre-filter Included



Order Number	Your Price Each
18 883 01-S1	\$17.97

### Fits Command Pro CH260, CH270

Pre-filter Included



Order Number	Your Price Each
17 883 07-S1	\$20.49

### Fits XT Series XT6, XT650, XT675, XT7, XT775, XT800

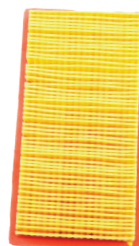

Order Number	Your Price Each
14 083 19-S	\$10.47

### Fits 7000 Series 7000 Series KT715 KT745



Pre-filter Included

Order Number	Your Price Each
32 883 09-S1	\$20.97

# Kohler OEM STARTERS



Order Number  
32 098 10-S  
**Price**  
**\$198.89**

Fits Kohler Courage Twin Engines. CH620, CH640, CH680, CH670, CH682, CH730, CH732, CH740 and others.

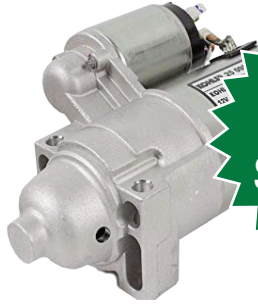

Order Number  
25 098 24-S  
**Price**  
**\$209.98**

Fits Kohler Command Twin. Includes starter solenoid.



**Kohler Vacuum Fuel Pump**  
Fits Kohler CH18-CH750, CV18-20, SV700 - SV840, ZT710 - ZT740.

Order Number: 24 393 16-S  
**List Price \$36.09**

**Sale Price**  
**\$24.89**



**Kohler Fuel Pump**  
Used on Kohler CH18, CH20, CH23, CH25, CH27, CH620, CH640, CH670, CH680, CH730, CH740, CH750 engines.

Order Number: 24 559 10-S  
**List Price \$147.98**

**Sale Price**  
**\$139.60**



Order Number: 25 050 21-S  
**Price \$6.98**  
Fits Kohler CH11-CH16, CH410-CH450, CV13-CV16, CV430-CV493



Order Number: 24 050 03-S  
**Price \$59.89**  
Kohler EFI Fuel Filter  
Fits Kohler EFI CH26, CH735, CH745, CV26, CV735, CV745, EFI LH775



Order Number: 24 050 13-S  
**Price \$8.95**  
Fits Kohler CH18-CH25, CH620-CH742, CH750-CH1000, CV18-CV25, CV620-CV742, ECH630-ECH749, ECV630-ECV1000, SV710-SV840, LH630

## Fits Command CV11 - CV16

Pre-filter Included

Order Number	Your Price Each
12 883 05-S1	\$15.89



## Fits Command Pro CV11 - CV16, CV430 - CV493

Pre-filter Included

Order Number	Your Price Each
12 883 10-S1	\$15.89



## Fits Command CH11-CH16, CH410-CH450, M18-M20, KT17, KT19

Pre-filter Included

Order Number	Your Price Each
47 883 01-S1	\$21.89



## Fits Confidant ZT710 - ZT740

Pre-filter Included

Order Number	Your Price each
16 883 01-S1	\$27.49



## Fits Confidant ZT710 - ZT740, 7000 Series KT715 - KT745

(W / Pro Performance Filtration)

Pre-filter Included

Order Number	Your Price Each
16 883 04-S1	\$20.47

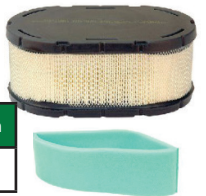

## Fits Courage SV470 - SV620

Pre-filter Included

Order Number	Your Price Each
20 883 06-S1	\$18.49



## Fits Courage SV710 - SV740

Pre-filter Included

Order Number	Your Price Each
32 883 03-S1	\$18.49



## Fits Courage PRO PRO SV810 - SV840

Pre-filter Included

Order Number	Your Price
32 883 06-S1	\$19.98



**Kohler**  
Maintenance Kits

Next  
Page

A regular schedule of preventive maintenance with genuine KOHLER parts helps: engine performance, Ensures easy starts, Extends engine life Prevent repairs and Support warranty protection.



### FOR COMMAND PRO 824CC

Kit Contains: Air Cleaner, Pre-Cleaner, Oil Filter, Fuel Filter, Oil (3) and Spark Plugs (4)

Order Number	Your Price Each
19 789 01-S	<b>\$79.95</b>



### FOR COURAGE SINGLE

Kit Contains: Air Cleaner, Pre-Cleaner, Oil Filter, Fuel Filter, Oil (2) and Spark Plug

Order Number	Your Price Each
20 789 01-S	<b>\$59.95</b>



### FOR COMMAND TWIN

Kit Contains: Air Cleaner, Pre-Cleaner, Oil Filter, Fuel Filter, Oil (2) and Spark Plug (2)

Order Number	Your Price Each
24 789 01-S	<b>\$64.95</b>



### FOR COMMAND PRO TWIN

Kit Contains: Air Cleaner, Pre-Cleaner, Oil Filter, Fuel Filter, Oil (3) and Spark Plugs (2)

Order Number	Your Price Each
24 789 02-S	<b>\$64.95</b>



### FOR HDCA

Kit Contains: Air Cleaner, Oil Filter, Fuel Filter, Oil (3) and Spark Plugs (2)

Order Number	Your Price Each
25 789 01-S	<b>\$69.95</b>



### FOR COMMAND PRO TWIN HDAC EFI MAINTENANCE

Kit Contains: Air Cleaner, Oil Filter, Fuel Filter, Oil (3)

Order Number	Your Price Each
25 789 03-S	<b>\$69.95</b>



### FOR COURAGE TWIN

Kit Contains: Air Cleaner, Pre-Cleaner, Oil Filter, Fuel Filter, Oil (2) and Spark Plugs (2)

Order Number	Your Price Each
32 789 01-S	<b>\$59.95</b>



### FOR 7000 SERIES

Kit Contains: Air Cleaner, Pre-Cleaner, Oil Filter, Fuel Filter, Oil (2) and Spark Plugs (2)

Order Number	Your Price Each
32 789 02-S	<b>\$59.95</b>



### FOR 7000 SERIES PRO

Kit Contains: Air Cleaner, Pre-Cleaner, Oil Filter, Fuel Filter, Oil (2) and Spark Plugs (2)

Order Number	Your Price Each
32 789 03-S	<b>\$59.95</b>



# KOHLER® PRO 300 HOUR OIL CHANGE KITS



Kohler PRO 10W-50 full synthetic oil and Kohler PRO extended life oil filters, when paired together, triple the oil change interval from 100 to 300 hours on Kohler gas engines.

- Reduces annual oil change costs by up to 50% and improves equipment up-time and productivity.
- Kohler PRO 10W-50 is engineered by Amsoil as a premium lubricant specifically for air-cooled engines.
- 10W-50 viscosity ensures all-season performance.
- Formulated for lower oil consumption than comparable conventional oil.
- Increased wear protection under extreme temperatures and operating conditions.
- Includes extra corrosion inhibitor for superior protection during seasonal storage.
- Kohler PRO Extended life oil filter features robust construction with premium media for extra capacity and superior filtration.

Order Number	Engine Family	Models	Oil Filter + 10W-50 Oil	SALE PRICE
25 850 01-S	Command Pro	CV173, CV200, CV224	1 Quart	<b>\$39.95</b>
25 850 02-S	5400, 6600 & 7700 Series, 7500 Series EFI	KS530-595, KT610-620 KT715-745, EKT730-750	2 Quarts	<b>\$59.95</b>
	Courage Single & Twin	SV470-620, SV710-740		
	Confindant Confindant EFI	ZT710-740, EZT725-750		
	Command, Command Pro Command Pro EFI	CV11-16, CV17-25, CV30-CV493, CH11-16, CH18-25, CH410-450 CV620-752, ECV630-749 CH620-752, ECH630-749		
	Aegis, Aegis EFI	LH690-775-ELH775		
25 850 03-S	Command PRO	CH/CV940-980 ECH/ECV940-980	3 Quarts	<b>\$69.95</b>



# Original Equipment Air Filters

**Fits models  
540000 & 610000  
Engine series  
2 1/2"IDx4 1/8"OD  
x10 3/4"HT**



Order Number	Your Price
841497	<b>\$24.89</b>
821136 (Inner)	<b>\$23.49</b>

**Fits ELS & Pro Series  
engines. V-twin  
16-27 HP engines**



Order Number	Your Price
792105	<b>\$20.99</b>
792303 (Pre)	<b>\$8.59</b>

**Fits Model 44 & 49  
Cyclonic Filter**



Order Number	Your Price
798897	<b>\$22.90</b>
593217 (Pre)	<b>\$6.29</b>

**Fits V-Twin Vanguard,  
29000, 303400,  
400400  
5-5/8 x 7 x 2-1/4**



Order Number	Your Price
394018S	<b>\$13.99</b>
272490S (Pre)	<b>\$4.49</b>

**Fits Single Cylinder  
20-21 HP engines**

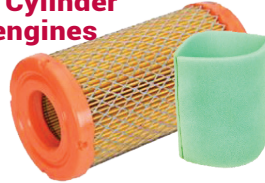

Order Number	Your Price
793569	<b>\$15.95</b>
793685 (Pre)	<b>\$4.79</b>

**Fits 3/LC Filter,  
Models 540000  
& 610000 series**



Order Number	Your Price
820263	<b>\$22.99</b>

**Fits V-Twin  
Vanguard Engines  
5-1/2 x 7-3/4 x 2-1/4in**



Order Number	Your Price
692519	<b>\$18.99</b>
692520 (Pre)	<b>\$5.89</b>

**Fits 9.5 Hp  
Briggs Horizontal  
engines**

Pre-filter Included



Order Number	Your Price
590601	<b>\$17.89</b>

**Fits Vanguard  
200 Series  
Engines**



Order Number	Your Price
596760	<b>\$18.89</b>

**Fits 125 Series  
Engines**



Order Number	Your Price
595853	<b>\$10.95</b>

**MAINTENANCE KITS**

	Order Number	Description	Price
	84004937	For Vanguard V-Twin 12-21 HP Engines	<b>\$59.95</b>
	84002317	Professional Series 24, 25 & 27 GHP V-Twin Engines	<b>\$54.95</b>
	84002316	Commercial Series 20, 25 & 27 GHP V-Twin Engines	<b>\$75.95</b>
	84002318	Vanguard 810cc V-Twin EFI, Oil Guard Engines, 37 HP Blig Block EFI Oil Guard Engines	<b>\$99.95</b>
	84002315	810cc V-Twin Non-Oil Guard Engines, 28, 31, 32, 35 & 37 HP EFI Non-Oil Guard Engines	<b>\$69.95</b>



**Briggs Oil Filter**  
For pressure Lubrication & 3/LC gas engines  
Order Number: 491056  
**Price . . . \$8.95 ea.**  
12 or more  
**PRICE . . . \$7.39 ea.**



**Briggs Oil Filter**  
Vanguard engines 5 - 14 HP, HT 2-1/4"  
Order Number: 492932S  
**Price . . . \$8.39 ea.**  
12 or more  
**PRICE . . . \$6.39 ea.**



**Briggs Oil Filter**  
Oil filter for ELS Engines  
Order Number: 696854  
**Price . . . \$10.99 ea.**  
12 or more  
**PRICE . . . \$9.49 ea.**



**Briggs Oil Filter**  
Oil filter for Model 12 Professional series  
Order Number: 795990  
**Price . . \$13.79 ea.**  
12 or more  
**PRICE . . \$12.99 ea.**



**Briggs Oil Filter**  
Oil filter for 3LC Engines  
Order Number: 820314  
**Price . . \$21.49 ea.**  
12 or more  
**PRICE . . \$18.49 ea.**



**Briggs Oil Filter**  
Oil filter for Vanguard Engines  
Order Number: 842921  
**Price . . \$10.49 ea.**  
12 or more  
**PRICE . . \$8.49 ea.**



**Briggs Oil**  
SAE 30 Oil  
18 oz Bottle  
Order Number: 100005  
**Price . . \$4.99 ea.**



**Vanguard Synthetic Oil**  
SAE 15W-50 Oil  
32 oz Bottle  
Order Number: 100169  
**Price . . \$10.49 ea.**  
12 or more  
**PRICE . . \$9.49 ea.**



**Vanguard Synthetic Oil**  
SAE 15W-50 Oil  
5 qt. Bottle  
Order Number: 100170  
**Price . . \$54.95 ea.**  
4 or more  
**PRICE . \$49.95 ea.**



**Briggs Oil**  
SAE 30 Oil  
48 oz Bottle  
Order Number: 100028  
**Price . . \$15.98 ea.**



**Briggs Synthetic Oil**  
SAE 5W-30 Oil  
32 oz Bottle  
Order Number: 100074  
**Price . . \$10.95 ea.**



**Oil Filter Wrench**  
Fits 2-1/2" to 4-1/2" Oil Filters,  
20 Degree Jaw Angle.  
Teeth provide non-slip grip  
Order Number: 752-836  
**Price: \$34.95**



**Hour Meter**

Tach/Hour Meter. Records actual running of engine. Non-Erasable. Shows Engines RPMs (Read up to 9,000 RPMs). Alerts you to lube (Grease) & Change Oil (25 Hour Intervals). No battery required, Triggered from the Spark Plug Wire. CE Certified.



### 4 Gallon Smith Multi-Use Li-ion S2E Back Pack

The Smith Multi-Use 4 Gallon Lithium-Ion Powered Backpack Sprayer is the ideal applicator that provides consistent, repeatable performance. Spraying up to 50 gallons on one charge of the 18V lithium-ion battery, this sprayer has completely eliminated the need to ever pump again, saving time, energy...and money!

**Order Number. 190576**

**Sale Price: \$254.<sup>95</sup>**



### 2 Gallon Smith Multi-Use 7.2V Li-Ion Sprayer

With faster flow rates, consistent output pressure and no pumping, The Smith Multi-Use 2 Gallon Battery Powered Sprayer with Pump Zero™ technology revolutionizes the compressed air sprayer industry. This lithium-ion powered sprayer will save the user time, money and energy. The rechargeable battery, built into the pump handle, enables the user to spray up to 24 gallons of both liquids and wettable powders on a single charge.

**Order Number. 190671**

**Sale Price: \$128.<sup>69</sup>**



### 2 Gallon Smith Multi-Use Pump Sprayer

The Smith Multi-Use 2 Gallon Manual Pump Sprayer provides versatility for countless professional liquid applications, including turf, pest control and concrete chemicals. With Viton seals and premium components throughout, this unit was built to get the job done.

**Order Number. 190684**

**Sale Price: \$53.<sup>95</sup>**



### 4 Gallon Smith Multi-Use S2 Backpack

The Smith Multi-Use 4 Gallon "No Leak" internal pump backpack is designed with safety and comfort in mind. The internal pump technology eliminates chemicals dripping down the user's back. With premium components throughout, including a thick, adjustable harness with padded straps and chest strap, this sprayer is the workhorse that will get the job done.

**Order Number. 190670**

**Sale Price: \$119.<sup>95</sup>**



# Mechanics 1st Choice

## REPAIR SHOP TOOLS

### Magnetic Parts Tray & Cup



#### 6" Round Tray

Magnetic Parts Tray 6"round, stainless steel. Scratch resistant rubber coating. Keeps bolts, nuts and small parts in one place.

**Order Number: 16113**

**Price: \$12.95**



#### 6" Magnetic Parts Cup

Magnetic Parts Cup 6"with angled base. Green, scratch resistant coating. Helps to eliminate misplacing nuts, bolts and other small parts.

**Order Number: 16209**

**Price: \$20.95**



### Mechanics-Grade NITRILE GLOVES

Duraskin Nitrile gloves are designed for performance with better grip and stronger material. Keep hands clean and protected from dirt, oil, cleaners and chemicals in the shop or on the job.



Touch-Sensitive

#### 4MM MECHANIC DUTY

Order Number	Description	Price ea.
13040	Medium - Box of 100 Gloves Color: Black, Powder Free	\$44.95

#### 4MM MECHANIC DUTY

Order Number	Description	Price ea.
13060	Large - Box of 100 Gloves Color: Black, Powder Free	\$44.95

#### 4MM MECHANIC DUTY

Order Number	Description	Price ea.
13061	X-Large - Box of 100 Gloves Color: Black, Powder Free	\$44.95

Used In  
Our Own  
Shops!



Magnetic Tool Tray 9"X 5"heavy duty, stainless steel, powerful magnets with scratch resistant rubber coating. Ideal for holding small parts and tools

**Order Number: 16402**

**Price: \$20.85**

### 9" X 5" Magnetic Tool Tray

### SHOP TOOLS

#### Hand-E Quick Funnel

Molded for holding bottles  
Fits multiple openings  
Holds 1 qt.



Order Number  
750-724  
**Price \$5.29**



#### Oil Drain

Easy Pouring Design  
Made of Plastic  
Holds 15 qts.

Order Number:  
750-732  
**Price \$34.93**



#### Oil Extractor

For use on Lawnmowers, tillers, snow blowers, ATV's & transmissions.  
3 Qt Capacity  
No Electricity needed.

Order Number:  
051-680  
**Price \$98.89**

# Mechanics 1<sup>st</sup> Choice

## REPAIR SHOP TOOLS



### PVC Electrical Insulating Tape

7 Mil Tape, 3/4" Wide x 60 Ft Long

Order Number: 9023

Price: \$3.95



### Ratchet Starter Remover

A real time saver to be used with 1" socket, any drive or 1/2" drive. Made of heavy gauged steel. Also fits newest B&S ratchets.

Order Number: 19244

Price: \$10.99



### Alcohol Content Tester

Kohler OEM Tester  
Test Fuel for E10/E20/E85 in fuel.

Order Number: 25 455 11-S

Price: \$7.45



### Throttle Wire Bending Tool

Throttle Wire bending tool for making Z bends and curls in throttle and choke wire.



Order Number: 42-455

Price: \$7.95



### Heavy Duty Three Jaw Gear Puller 4"

BICO gear pullers are drop-forged and feature heat treated screws and floating screw center points. Jaws are adjustable and reversible for application to all gear removal jobs.

Order Number: 9020

Price: \$61.59



### Electrical Wire Stripper/Crimper Tool

Electrical Stripper/Crimper Tool. The fast, easy and professional way to strip electrical wire. Used to strip lawn and garden wire.

Order Number: 6718

Price: \$22.85



### Combination Internal External Snap Ring Pliers

Compress internal rings with one pair and expand external rings with the other. Comes complete with four sets of tips in a plastic box.

Order Number: 1725

Price: \$25.85



### 3 Way Ratchet

3-in-1 Ratchet. Fits 1/4" (6.35mm), 3/8" (9.52mm) & 1/2" (12.7mm) square drive sockets.

Order Number: 14124

Price: \$26.65

# Mechanics 1<sup>st</sup> Choice

## REPAIR SHOP TOOLS



### Ignition Spark Tester

Checks the integrity of the Electrical Ignition & Magneto/Coil Ignition Systems of Lawnmowers, Boat Motors, Motorcycles. The tester checks both current & voltage & will indicate fouled electrodes.

Order Number: 7731

Price: \$13.15



### Adjustable Ignition Spark Tester

Tests for no start conditions and for Spark Strength. Adjustable gap allows for different Spark Gap requirements of different systems from 0 to 40,000 Volts. Gauge background makes spark easy to see for accurate measurement. Alligator Clip securely fastens to ground.

Order Number: 9773

Price: \$34.25



### Circuit Tester

Circuit tester checks all 6 and 12 volts systems. Locates shorts, grounds and open circuits. Made in the USA

Order Number: 9835

Price: \$19.95



### Ignition & Spark Tester

Spark Tester. Plug in between the coil and spark plug. Lights up when spark is present.

Order Number: 9099

Price: \$19.00



### Wireless Tachometer

Accurately Reads R.P.M. in all 2 & 4 Cycle Single Cylinder Engines. 0 to 15,000 R.P.M. Scales. Solid State. Uses 9 Volt BATTERY, NOT INCLUDED. Model No. 1082 Dixon

Order Number: 9073

Price: \$154.00



### Charging System Tester

Checks Battery Condition & Starting as well as Charging System. Both 6 & 12 Volt. Full Instructions. Model #1092 Dixon.

Order Number: 9074

Price: \$77.89



### Digital Engine Tachometer

Different settings to measure RPM on 2 stroke and 4 stroke engines. Can be used wireless (pulse activation) or wired by using clip on lead provided. Measures RPM from 100 to 19,000 with +/- 10 RPM accuracy level. 0.5 second refresh rate. Similar to PET-1000R & Echo 99051130017

Order Number: 15344

Price: \$89.95

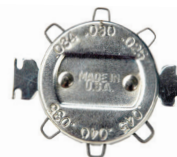

### Spark Plug Gap Gauge

With electrode adjusting tools, Thousand & Metric equivalents

Order Number: 1707

Price: \$5.25



### Ammeter

Universal-Mounts easily with 2 nuts provided.

Order Number: 9019

Price: \$16.59

# Mechanics 1<sup>st</sup> Choice

## REPAIR SHOP TOOLS



### Safety Seal Slim Refill Tire Repair

Self vulcanizing, easy to use tubeless tire repair system. Comes with insertion tool, spreader probe, lube, spare needle, allen wrench, blades and seal cords.

Order Number: 8081

Price: \$125.00



### Stop & Go Tire Repair Kit

Stop & Go Tire Repair Kit, # 1085 Deluxe Model Tire Plugger contains, Spring Loaded Plug Gun, Nozzle & Probe Tool, Tire Reaming Tool, Retractable Razor Knife, (15) 3/4"x 5/16" Mushroom Shaped Plugs.

Order Number: 15929

Price: \$71.75



### Stop & Go Tire Repair Plugs

Stop & Go tire repair plugs 50 pack, 3/4" x 5/16" mushroom shaped plugs used with our 15929 tire plugger.

Order Number: 15971

Price: \$20.95



### Emergency Cable Repair Kit

Helix Emergency Cable Repair Kit. Two cable wire diameter sizes (.047" and .055) each 6.5 feet long and an assortment of cable ends for throttle, brakes and clutch. Small and compact to be carried on equipment.

Order Number: 16598

Price: \$19.25



### Utility Tire Air Powered Bead Expander

Ken Tool Utility Tire Air Powered Bead Expander helps seat beads on hard to seat tubeless lawn and garden tires. Fits 10"- 22" diameter tires.

Order Number: 15972

Price: \$235.00



### Utility Air Powered Bead Expander

Ken Tool Utility tire air powered bead expander helps to seat beads on hard to seat tubeless lawn and garden tires. Fits 14" to 26" diameter tires.

Order Number: 16066

Price: \$250.00



### Tire Changer

For lug-center or bearing-in hub wheels. Designed for 4" to 12" tires. Any wheel is secured onto the non-skid base plate by simply positioning and tightening the "quick adjust" center post onto the threaded rod. This unique design allows the operator to change small tires and switch wheel sizes or styles very quickly.

Order Number: 67-214

Price: \$320.97



### Bead Seater

The Oregon® bead seater tire inflator has a "fire hose" type release valve and an attached air hose for use as an air bubble.

Order Number: 67-221

Price: \$316.20



# Mechanics 1<sup>st</sup> Choice

## REPAIR SHOP TOOLS



### Valve Seat Cutter Kit

This gives you the tools to do the complete job on most air-cooled engines. The same accurate and precision kit that is used throughout the air-cooled engine industry now has a tool with a 15 top angle and 60 bottom angle to repair your engines as the factory recommends.

**Contains:** 1 - 31 & 46 Head, 1-5/16" diameter 1 - 15 & 60 Head, 1-5/16" diameter 1 - 1/4" Pilot 1 - 9/32" Pilot 1 - 5/16" Pilot 1 - 11/32" Pilot 1 - 8mm Pilot Wrenches Pilot Puller Pin Fitted Tool Case

**Order Number: 1741**

**Price: \$635.39**



### Valve Seat Cutter kit

This valve seat reconditioning kit has a specially engineered cutting head with a 31 angle on one side and a 46 on the other. Newway Valve seat cutter is a hand operated tool for most air-cooled engines.

**Contains:** 1 - 31 & 46- 5/16" Diameter adjustable to 1-9/16" 1 - 1/4" (.248) Pilot 1 - 9/32" (.279) Pilot 1 - 8mm Pilot for worn 5/16" Guide Wrenches Pilot Puller Pin Fitted Tool Case Includes all parts listed above plus 11/32" Pilot and longer blades. Kit will also cut all known Wisconsin Engine Seats except Models VQ4 and VR4. The cutter head is adjustable to 1-11/16" diameter.

**Order Number: 1742**

**Price: \$412.39**

#250 Blades for previous model 102A. One blade per pack

**Order Number: 1750**

**Price: \$26.59**

#251 Blades for previous model 102W. One blade per pack

**Order Number: 1751**

**Price: \$26.59**



### Cutter Head Assembly For NEWAY

Newway #124 Cutter Head Assembly. 15 & 60 Head. Use with Rotary's # 8940, 1741 & 1742

**Order Number: 9305**

**Price: \$265.00**



### Valve Seat Cutter Kit LG3000

Newways's latest & most complete Valve Seat Cutter Kit, puts Precision Reconditioning at your finger tips. The LG-3000 contains everything you need to recondition Valve Seats for most Four-Cycle Power Equipment - Including the newest overhead Valve Engines on the market

**Contains:** 1 - 31 & 46 Head, 1-15/16 Dia 1 - 31 & 46 Head, 1-1/8" Dia, 1 - 60 Head, 1" Dia 1 - 15 & 60 Head, 1-5/16" Dia, 1 - 6.02mm pilot 1 - 6.05mm Pilot, 1 - 1/4" Pilot, 1 - 9/32" Pilot, 1 - 5/16" Pilot 1 - 8.0mm Pilot, T Wrench, Hex Keys, Brush, Pilot Puller Pin, Fitted Tool Case, Instructions

**Order Number: 8940**

**Price: \$995.00**



### Valve Seating Tool

Suction Cup Style with 15/16" and 1-1/16" Diameter cups. Fits all small engines.

**Order Number: 1731**

**Price: \$6.19**



### Piston Stop Tool

Piston stop tool. Locks pistons in 2-Cycle engines to help removal; of clutches & flywheels. 14mm thread machined steel. Can replace Stihl 1007 191 1200

**Order Number: 12614**

**Price: \$4.00**

# Mechanics 1<sup>st</sup> Choice

## REPAIR SHOP TOOLS

**14 to 18mm**



### Spark Plug Thread Chaser

Renews damaged threads. Removes Carbon & Corrosion with a few turns. Allows Firm Seating of Plugs. Assures Metal to Metal Contact for Effective Heat Transfer.

Order Number. 5827

Price: \$19.00

**10 to 14mm**



### Spark Plug Thread Chaser

Renews damaged threads. Removes Carbon & Corrosion with a few turns. Neoprene ring holds chaser snugly in socket.

Order Number. 9031

Price: \$20.00

**2" to 4" Capacity**



### Ring Expander

For installing & removing Piston Rings, from 2" TO 4" capacity, without the danger of breakage or distortion. All rings expanded whether Step-Cut or Diagonal Cut.

Order Number. 9052

Price: \$25.50



### Ring Compressor

Piston ring compressor is adaptable to all types of rings. Oregon replacement parts are built to meet or exceed OEM standards. Capacity: 1-3/4" to 3-1/2"

Order Number. 1749

Price: \$17.39



### Small Engine Hone

Fits cylinders with 1-1/2" to 3" diameter. Easy adjustments to any small engine application. Complete with Stone - Plated.

Order Number. 1704

Price: \$35.50



### Carburetor Jet Cleaning Tool

Helix Carburetor Jet Cleaning Tool, to clean clogged jets and passageways inside the carburetor. Kit has ten wire sizes to cover the most common jet sizes, come in Helix storage case.

Order Number. 16597

Price: \$26.39



### Replacement Stones

Replacement stones for 1704 Cylinder Hone. 2" Length x 5/16" width. Set of three

Order Number. 1705

Price: \$16.00

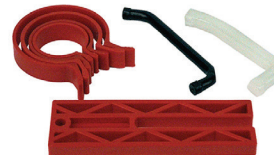

### Piston Ring Assembly Tool For Husqvarna

Piston Ring Assembly Tool Kit. Replaces Husqvarna 502 50 70-01. Useful for assembling pistons and cylinders on chainsaws. 4 Sizes of clamps. Give yourself a third hand with this kit. This kit will compress piston rings ranging from 30mm to 60mm in diameter. Includes a piston support block and piston stop.

Order Number. 14626

Price: \$14.00

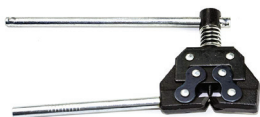

### Roller Chain Breaker

Lightweight roller chain breaker for use on sizes 1/4" - 3/4" pitch chain. Will work on sizes 35, 40, 41, 42, 43, 50 and 60 chain. Made in the USA.

Order Number. 15797

Price: \$29.99

# Mechanics 1<sup>st</sup> Choice

## REPAIR SHOP TOOLS



### Valve Spring Compressor

Exclusive Valve Lifter frees both hands. Exclusive Lift Wedge eliminates use of screwdrivers and lets you get under the Retainer Cap with ease. Rugged all steel construction. Fits all cycle engines.

**Order Number. 9252**

**Price: \$55.15**

Small Replacement Jaw Fits 9252

**Order Number. 9253**

**Price: \$11.50**

Large Replacement Jaw Fits 9252

**Order Number. 9254**

**Price: \$11.50**



### Valve Spring Compressor

For removing & replacing Valve Springs of Briggs & Stratton Engines

**Order Number. 9054**

**Price: \$49.00**



### FlyWheel Puller

Genuine Briggs & Stratton replacement Puller Flywheel. Size: Large, Hole Distance 2-13/16" or 2.820 (71.4375 mm)

**Order Number. 19203**

**Price: \$20.89**

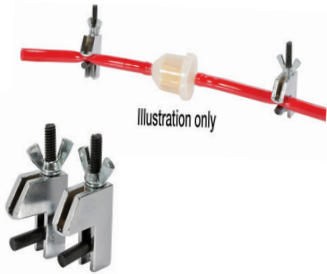

### Hose Pinch Tool

Helix Tubing Clamp/Hose Pinchers. A quick and easy way to pinch off fuel line without damaging the line. Nickel plated. Sold in pairs. Fuel line and filter not included.

**Order Number. 14859**

**Price: \$13.89**

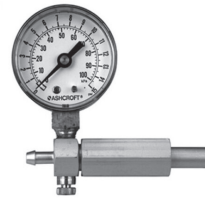

### Crankcase Pressure Gauge

Leak Detector, Pop-Off Gauge Fuel Pressure Gauge (15 PSI)

**Order Number. 11321**

**Price: \$86.25**



### MAGNA-MATIC Blade Balancer

Blade Balancer made of the finest steel with sealed bearings for precision balancing and strong magnets to hold a blade while balancing. This is an American made Magna Matic MAG-1000 Balancer.

**Order Number. 9788**

**Price: \$345.00**

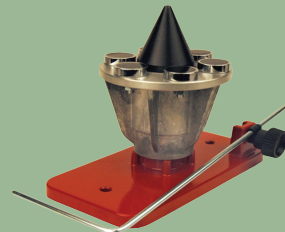

### Tecomec Magnetic Blade Balancer

Tecomec Magnetic Wall Mount Blade Balancer. 6 Magnets allow better stability. Imported.

**Order Number. 13216**

**Price: \$149.00**

### Spark Plug Wrench



Fits: 3/4-inch Short Plug & 13/16-inch Regular Plug.  
14mm Wrench  
Includes L bent rod to turn Wrench.  
Fits most common Small engine Spark Plugs

**Order Number. 1291**  
**Price \$3.29**

### Mower Deck Leveler



Oregon Deck Leveler  
Accurately measures height of deck from ground on all sides. Place gauge on Flat concrete floor for best results. Measure 4 corners of deck. Make adjustments to deck hanging chains or rods.

**Order Number. 42-095**  
**Price \$9.83**

Visit us at [propartsdirect.net](http://propartsdirect.net) to learn on how you can become a small engine repair shop account. Enjoy repair shop discounts and specials. If you are tax exempt we can do that to!

# Mechanics 1<sup>st</sup> Choice

## REPAIR SHOP TOOLS

### Service Repair Tags



Made of durable material, with reinforced eyelets. Will help organize information, minimize errors & alert personnel to special instructions. (100 per pack) Wire attached.  
 SIZE 3-1/4" X 6-1/4"

Order Number: 9087

Price: \$0.49 ea.

### Weather Resistant Service Maintenance Tag



Service Maintenance Tag made of durable weather resistant material. Will help record maintenance information. Can be attached to seat base for future reference. Package contains 50 tags (3-1/8"x 6-1/4") and 50 beaded ball type security ties. Priced individually, order in multiples of 50. Min 50

Order Number: 16480

Price: \$0.85 ea.



### Service Parts Bags

Service Parts Bag, Measures 8-3/8" X 12, Writing area of 5" X 1-1/2" & has a hole for hanging. NOT A ZIP-LOCK BAG

Order Number: 7256

Price: \$0.40 ea.



### Belt Measurer

Belt Measurer. Measures 3/8, 1/2, & 5/8. Fractional Horse-Power Belts as well as A & B Section Industrial Belts up to 110.

Order Number: 9108

Price: \$56.50

### Belt Gauge Extender

Belt Gauge Extender. Fits Rotary 9108 Belt Measuring Gauge. Adds 40" length capacity to our current 110" gauge.



Order Number: 16263

Price: \$121.00



### JB Weld Compound

Repairs, Fills, & Bonds: Iron, Steel, Copper, Aluminum, Brass, Bronze, Pewter, Wood, Porcelain, Ceramic & Plastic.

Order Number: 9077

Price: \$11.00



As Seen on Taryl Fixes All!

Order Number: 710XX155

Price: \$13.99

### HV-350 Compound

Due to its tremendous elasticity, HV-350 is ideal for high-vibration applications. HV-350 can be stretched up to 600 percent of its original length. Works Great on Plastic

▶ Youtube

# Carlisle Tires

## TURF MASTER



Size	Order Number	PLY	Price
13 x 6.50 - 6	5112491	4	\$46.95
15 x 6.00 - 6	5112521	4	\$52.95
16 x 6.50 - 8	5114011	4	\$68.89
16 x 7.50 - 8	5114021	4	\$74.89
18 x 6.50 - 8	5114171	4	\$84.95
18 x 8.50 - 8	5114041	4	\$88.59
20 x 8 - 10	5114281	4	\$92.95
20 x 10 - 8	5114051	4	\$129.95
20 x 10 - 10	5114161	4	\$129.95
23 x 9.50 - 12	6L08381	4	\$159.95
23 x 10.50 - 12	5114081	4	\$159.95
24 x 9.50 - 12	511434	4	\$129.95
24 x 12 - 12	5114091	4	\$178.88

## TURF-SAVER



Size	Order Number	PLY	Price
11 x 4.00-5	5110101	2	\$29.88
13 x 5.00-6	5110211	4	\$34.95
13 x 6.50-6	5111861	4	\$42.95
15 x 6.00-6	5110301	2	\$34.95
16 x 6.50-8	5110961	4	\$44.88
18 x 6.50-8	5110991	2	\$56.95
18 x 8.50-8	5110711	4	\$76.88
18 x 9.50-8	6L05011	4	\$105.95
20 x 8.00-8	5110801	2	\$79.95
20 x 10.00-8	5111011	2	\$98.49

## SMOOTH



Size	Order #	PLY	Price
8x350-4	5120081	4	\$22.95
9x350-4	5120101	4	\$28.98
11x400-5	5120111	4	\$36.88
13x500-6	5120211	4	\$45.88
13x650-6	5121861	4	\$44.95

## RIB



Size	Order #	PLY	Price
13x5.00-6	5180211	4	\$32.95
13x6.50-6	5181861	4	\$38.88
15x6.00-6	5180311	4	\$37.88
16x6.50-8	5180961	4	\$64.88

## TUBES



Size	Order #	Price
13 x 500	71-096	\$10.85
15 x 600	71-102	\$11.45
410 / 350	71-610	\$8.08
18 x 850 / 950	71-104	\$23.83
20 x 800	71-004	\$23.23
16 x 650	71-816	\$14.85
20 x 10.00	71-100	\$27.22
23 x 1050	71-408	\$29.70
480/400/8	71-800	\$9.10
20x10x8	71-407	\$20.49
16x650x8	71-406	\$19.89
26x12x12	71-283	\$41.28
22X11X8	71-098	\$36.69
11x4x5	71-403	\$7.19

## MULTI TRAC



Size	Order #	PLY	Price
18x8.50x10	5743U11	4	\$98.88
18x10.50-10	5743E51	4	\$138.88
24x9.50-12	574338	4	\$149.95
26x12.00-12	5743611	4	\$189.95
23x9.50-12	574329	4	\$149.95

## OTR GRASSMASTER



Size	Order #	PLY	Price
18x850x10	6GM454	4	\$99.95
23x1050-12	6GM814	4	\$199.88
24x12x12	6GM874TL	4	\$214.95
25x12x12	6GM934	4	\$229.88



### BUY NOW & PAY LATER

PROPARTS DIRECT GIVES YOU THE OPTION TO BUY THE PARTS YOU NEED NOW AND PAY OVER TIME WITH AFFIRM. CHOOSE AFFIRM AT CHECKOUT TO APPLY FOR FIXED MONTHLY PAYMENT OPTIONS THAT FIT ANY BUDGET.

\*SUBJECT TO ELIGIBILITY. PAYMENT OPTIONS THROUGH AFFIRM ARE PROVIDED BY THESE LENDING PARTNERS: AFFIRM.COM/LENDERS

## Walker Carlisle Tires

5743U1

5743E51

5120211



Size	Order #	PLY	Price
18 x 8.50 x 10	5743U1	4	\$98.88
18 x 10.50 x 10	5743E51	4	\$138.88
13 x 500 x 6	5120211	4	\$48.88



5715-17



5715-18

Order Number	Description	Price
5715-24	8 x 300 x 4 Tire / Rim Pneumatic Tire	\$123.42
5715-23	Flat Free Version of 5715-17	\$118.79
72-756	Replaces 5715-18, 5715-23	\$89.95
5714-3	Sleeve 9 Inner	\$10.98

# THE NEWEST TURF TIRE FOR ZERO-TURN MOWERS

• Consistent hub height helps ensure the mower deck produces an even cut.

• Excellent lateral stability on hillsides and sloped surfaces, and outstanding operator comfort, even when navigating over curbs and other bumps.

• High performance compounds and an efficient contact patch designed to provide a longer life that is 2-3 times that of a pneumatic tire at equal tread depth.

*Why Tweels?*

**CALL US FOR FITMENT!**



Gravelly				Front Caster	Price	Rear Tire Size	Rear Tire	Price
Pro-Turn 200		5	52/60/72	49136	\$309.95	24x12x12	54411	\$749.95
Pro-Turn 400		5	52/60/72	49136	\$309.95	24x12x12	54411	\$749.95
Pro-Turn 300		5	48/52/60/72	49136	\$309.95	24x12x12	54411	\$749.95
Pro-Turn 500		5	52/60/72	49136	\$309.95	26x12x12	25913	\$943.00
Pro Turn 600		5	52/60/72	49136	\$309.95	26x12x12	25913	\$943.00

Exmark Toro				Front Caster (Spacer)	Price	Rear Tire Size	Rear Tire	Price
Radius	RAE708GEM48300	4	48	73818 (Spacer 40653)	\$249.95	22x11x12	37968	\$789.00
Lazer Z	LZX940EKC60600	4	60	73818 (Spacer 40653)	\$249.95	24x12x12	50357	\$859.95
Lazer Z	LZX980EKC726W0	4	72	73818 (Spacer 40653)	\$249.95	24x11x12	50357	\$859.95

Exmark OEM TWEEL				Order Number	Price	Rear Tire Size		
Tractus	Lazer Z	4	60	135-2286	\$889.95	24x12x12		
Tractus	Lazer Z	4	72	135-2287	\$889.95	26x12x12		



TWEEL Tires are the newest, hottest thing in the lawn industry. That being said, Michelin® is still learning what tires fit what machine. **Contact us with your model number to make sure you have the right fit.** New machines are being added monthly.

SCAG				Front Caster (Spacer)	Price	Rear Tire Size	Rear Tire	Price
Turf Tiger II	STTII-52V	4	52	73818 (Spacer 40653)	\$249.95	26x12x12	08189	\$849.95
V-Ride II	SVRII-52V	4	52	73818 (Spacer 40653)	\$249.95	24x12x12	77185	\$820.00
V-Ride II	SVRII-61V	4	61	73818 (Spacer 40653)	\$249.95	24x12x12	77185	\$820.00
Cheetah	SCZ72V	5	72	73818 (Spacer 38182)	\$249.95	24x12x12	54411	\$749.95

TORO				Front Caster (Spacer)	Price	Rear Tire Size	Rear Tire	Price
5000 Series	74915	4	60	73818 (Spacer 40653)	\$249.95	24x12x12	77185	\$820.00
6000 Series	74926	4	60	73818 (Spacer 40653)	\$249.95	24x12x12	50357	\$859.95
6000 Series	74928	4	72	73818 (Spacer 40653)	\$249.95	24x12x12	50357	\$859.95

Toro OEM TWEEL				Order Number	Price	Rear Tire Size		
X-Tweel	Titan HD, Z 2000	4		139-3649	\$789.00	24x12x12		
X-Tweel	GrandStand	4		139-7890	\$559.00	18x8.5x10		
X-Tweel	Certain Z Master Models	4		139-7891	\$789.00	24x12x12		

Wright				Front Caster (Spacer)	Price	Rear Tire Size	Rear Tire	Price
Wright Mowers	MMZ	5	52	52441 (Spacer 65019)	\$249.95	N/A	N/A	
Wright Mowers	MMZ	5	61	52441 (Spacer 65019)	\$249.95	24x12x12	54411	\$749.95
Wright Mowers	ZTO	5	52	N/A		24x12x12	54411	\$749.95
Wright Mowers	ZTO	5	61	N/A		24x12x12	54411	\$749.95



**NEW  
THIS  
YEAR!**

**Contact Us for Stinger Parts!**

# QA-3000SB/ST FAST Moving Parts

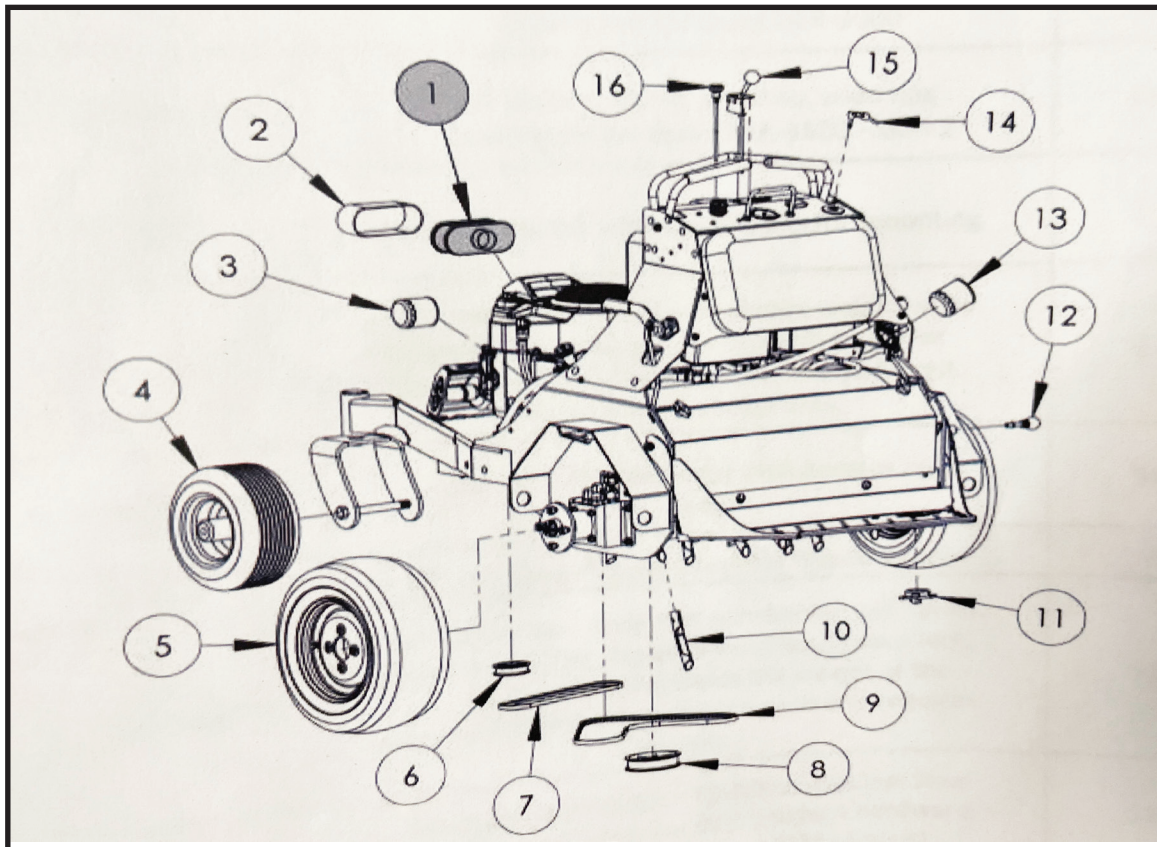

Order Number	Description	Price	Order Number	Description	Price		
1	11029-0031	Kawasaki Air Filter	\$17.80	9	40-2372ST	Drive Belt	\$25.00
2	Included W/ 11029-0031	Pre-Filter		10	10-0260ST	Ride on Tire	\$7.56
3	49065-0721	Kawasaki Oil Filter	\$9.49	11	50-1805ST	Foot Switch	\$37.50
4	40-0427ST	Caster Tire	\$95.00	12	10-1657ST	Plunger	\$36.50
5	40-2036ST	Drive Tire	\$145.00	13	40-1807ST	Hydro Oil Filter	\$16.00
6	40-0869ST	3" Flat Idler	\$21.50	14	50-1803KST	Set of Keys	\$11.00
7	40-2452ST	AX34	\$25.00	15	40-1608ST	Throttle Cable	\$45.50
8	40-1612ST	Large Flat Idler	\$53.00	16	40-1607ST	Choke Cable	\$38.00

## TRACTUS AIRLESS TIRES



Deck Width	Order Number	Price
60	135-2286	\$889.95
72	135-2287	\$889.95



### Anti-Scalp Wheel

Used on Exmark /  
Toro Commercial Riders  
Wheel Size: 5x2 3/4,  
Hub: 2 1/2" offset, Bore: 5/8

**Order Number 1-603299**

**Price: \$19.99**

**2 Or More  
\$17.99 ea.**



### Anti-Scalp Wheel

Alternative Part "Wheel Kit".  
Includes: Wheel, Bolts, Spacer,  
Washer & Nut.

**Order Number 10301**

**Price: \$14.88**

**2 Or More  
\$13.00 ea.**

## OEM Ultra-Vac Replacement Bags

Replacement bags with hard bottom. Does not include handle or frame

**44 / 48 / 52" Bag**

**60" to 72" Bag**



**2 or  
more  
\$70.95 ea.**

**Order Number : 116-3518  
\$74.95 ea.**



**2 or  
more  
\$70.95 ea.**

**Order Number : 116-0757  
\$74.95 ea.**

### Replacement Bag Exmark

Rear Bag replaces  
Exmark 103-0431,  
1-653566 and  
**116-0757**. This  
replacement bag  
is for the Exmark  
2-bag and 3-bag  
rear rider catchers.

The bag is made with black polyester  
material and has a back plastic pan and  
closely resembles the OEM product

**Order Number : 16741  
\$59.95 ea.**



**2 or  
more  
\$54.95 ea.**

## Exmark Catcher Parts



### Rubber Hood Latch

Used on 44 / 48 / 52 Baggers

Order Number 1-653403

**Price: \$63.99**



### Rubber Tube Seal

Used on 44 / 48 / 52 Baggers

Order Number 1-653561

**Price: \$16.99**



### Plastic Hood Catch

Used on 44 / 48 / 52 Baggers

Order Number 1-653404

**Price: \$31.99**



### Exmark Red Paint

12 oz. Can

Used on All Exmark Equipment

Order Number: 1-850337

**Price: \$21.99**

**2 or more \$20.99**

### Motion Control Dampener

Used on Exmark / Toro Commercial Riders

**Order Number 142-8117**

**Price: \$90.99**



## Exmark 60" & 72" Ultra-Vac Parts

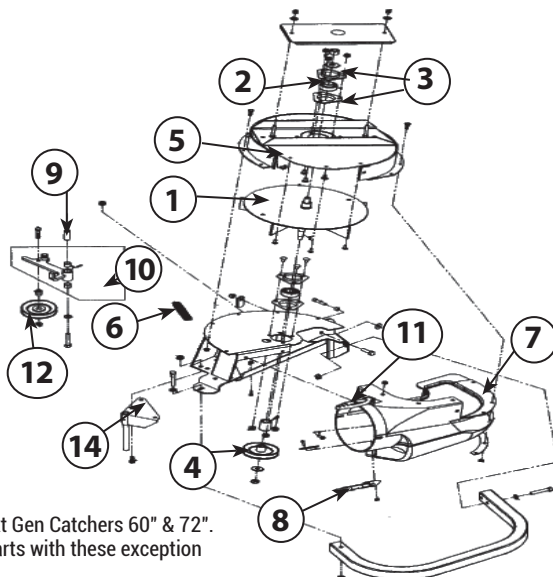

Newer Style Next Gen Catchers 60" & 72".  
Use the same parts with these exception

7	Chute Blower	109-2954	\$263.99
8	Latch Grass catcher	103-2898	\$27.99
14	Wld, Mount Pin	1-353050	\$14.99

### Ultra Vac Blower Assembly

#	Description	Order #	Price
1	Wld, Impeller	103-0455	<b>\$369.95</b>
2	Bearing, SPH. OD (2)	FH205-16	<b>\$32.88</b> (2 for \$27.89 ea.)
3	Housing, Flange (4)	1-513013	<b>\$4.49</b>
4	Sheave, Blower	103-0456	<b>\$44.99</b>
5	Wld, Upper Housing	103-3593	<b>\$453.99</b>
6	Spring, Idler	1-653331	<b>\$10.99</b>
7	Chute, Blower	103-4759	<b>\$305.99</b>
8	Latch, Grass Catcher	1-353054	<b>\$6.69</b>
9	Bushing, Idler Pivot	1-603044	<b>\$10.99</b>
10	Assembly, Idler with Bushings, Zerk & decals	103-0448	<b>\$129.99</b>
11	Latch, Rubber	103-2898	<b>\$27.99</b>
12	Pulley, Idler	103-0483	<b>\$44.99</b>
13	Bearing	1-653600	<b>\$17.99</b>
14	Wld, Mount Pin	103-0445-03	<b>\$57.99</b>



Exmark/Toro  
Fan Bearing  
Replaces 1-653346  
Order Number: FH205-16  
Price: \$32.88 ea.  
4+ \$27.89 ea.

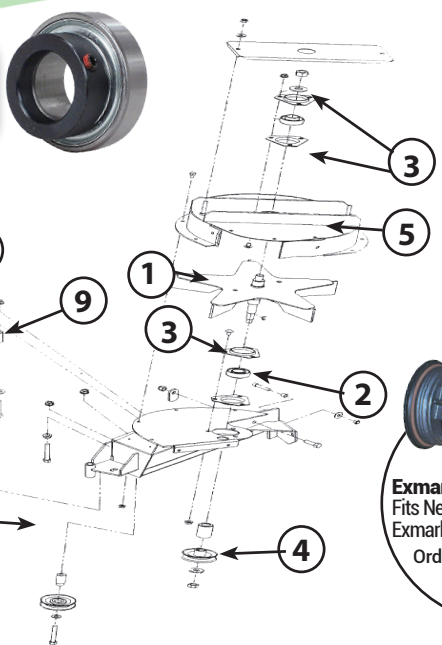

**Exmark / Toro Hydro Filter**  
Fits Newer Toro Riders,  
Exmark Next Gen Series.  
Order Number 117 0390  
**\$49.99**

44" - 48" - 52" Ultra Vac LHP Blower Assembly			
#	Description	Order #	Price
1	Wld, Impeller	103-3815	\$248.95
2	Bearing, SPH. OD (2)	1-653346	\$56.99
3	Housing, Flange* (4)	1-513013	\$4.49
4	Sheave, Blower*	103-1047	\$65.99
5	Wld, Upper Housing	103-3589	\$535.99
6	Spring, Idler	1-653331	\$10.99
7	Bearing (2)	1-653600	\$17.99
8	Pulley, Idler	1-653322	\$54.99
9	Bushing, Idler Pivot	103-0130	\$14.99
10	Pulley, Idler	103-1103	\$57.99
11	Assembly, Idler W./ Bushings, Zerk & Decal	103-2876	\$137.99
12	Pin, Grass Catcher	1-353050	\$14.99

\*Apply Mobil HTS grease (or a food-grade anti-seize) on bore of sheave and bearings

## Exmark Ultra-Vac Belts



Order Number	Fits	Price	2 or More
1-653332-SL	44" Ultra-Vac	\$25.99	
1-653333-SL	48" Ultra-Vac	\$28.99	
103-0866-SL	50" Ultra-Vac	\$30.99	\$28.99
1-653438-SL	52" Ultra-Vac	\$30.99	\$28.99
109-9249-SL	56" Ultra-Vac	\$30.99	\$28.99
103-0866-SL	60" Ultra-Vac	\$30.99	\$28.99
103-0867-SL	72" Ultra-Vac	\$30.99	\$28.99

## Exmark Hydro Oil

Specially designed oil for extreme mowing conditions. Field tested & proven formula offers maximum protection in all conditions.



1 Quart Bottle  
Order Number: 109 9828

**Price . . . \$17.89**  
**12 or more \$15.89 ea.**

1 Gallon Bottle  
Order Number:

116 1218  
**Price . . . \$52.99**



Exmark OEM Oil  
10W-50 Syn 1 Quart Bottle  
Order Number: 126-4143

**Price . . . \$12.59 ea.**  
**12 or more \$11.99 ea.**



20W-50 Syn 1 Quart Bottle  
Order Number: 135 3949

**Price . . . \$16.88 ea.**  
**12 or more \$15.89 ea.**



30/10W-50 Syn 1 Quart Bottle  
Order Number: 126-4143

**Price . . . \$12.59 ea.**  
**12 or more \$11.99 ea.**

## Ultra-Vac Assemblies

Exmark	Order Number	Description	Sale Price
	103-0401	44-48" Ultra Vac	\$1,395.99
	103-0400	52" Ultra Vac	\$1,434.99
	109-1024	50-56 Ultra Vac	\$1,337.40
	109-1128	60" Triton Deck Vac	\$1,598.95
	103-2991	60" - 72" Ultra Cut Series Vac (Series 2)	\$1,374.95
	109-9832	48" - 52" Ultra Cut Series Vac (Series 4-6)	\$1,699.95
	109-9836	60" - 72" Ultra Cut Series Vac (Series 4-6)	\$1,469.95



Don't See the Walker part you need? Call us at 800 305 9255.

### Blower Parts

Order Number	Description	Price
7543-0	10.5 Blower Assembly W/O Tube Replaces 7543	\$573.86
7526	10.5 Blower Tube Order with 7543-0 If Needed	\$47.79
7544	10.5 Blower Assembly	\$583.39
5542-3	9 Blower Assembly	\$530.04
6542-0	Blower Assembly	\$511.64
7545	10.5 Blower Wheel	\$132.00
6545	10 Blower Wheel	\$143.00
5515-2	Elbow Delivery Spout	\$71.55
7239-1	Blower Pulley ( Micro V)	\$39.51
5794-3	Discharge Chute W/Spring	\$85.59
8511-1	9.5 Delivery Chute w/ Clips	\$52.72
5268	Bearing V <b>2 Or More \$28.00 ea.</b>	\$32.95
7794-1	Discharge Chute	\$109.77
7406-1	Handle Grip Red	\$2.52
8960-15	Ignition Switch W/ Key	\$27.16

### Hydrostatic Drive Parts

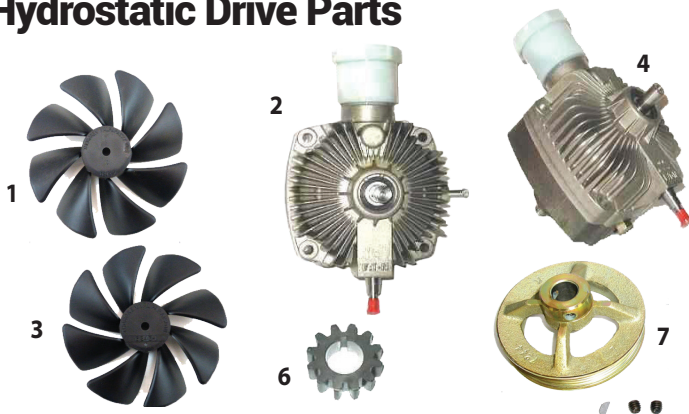

NÖrdber	Description	Price
1	6243-2 Hydro Fan, CCW (Used with 5025)	\$6.49
2	5025 Hydrostatic Drive, CCW (700-052)	\$1079.95
3	6243-1 Hydro Fan, CW ( Used with 5026)	\$6.49
4	5026 Hydro Static Drive, CW ( 700-051)	\$1079.95
6	6233-1 Pinion Gear	\$46.42
7	7244 Hydro Pulley	\$48.24

### Fuel Tank



New Style Fuel Tank Kit With Evap Control 4.7 Gallon Includes Fuel Filter, In Tank Replaces Walker 8046-3, 8046-9 Tanks

**Order Number** 8055-1 **Price** \$205.39

Remote Pre-Cleaner Fits All Walkers



**Order Number** 7026-3 **Price** \$62.60

### Blower Drive Belts



Order Number	Description	Serial Number Range	Price
8230	Engine To PTO Belt	92-12717 and on	\$39.95
7248	Ground Drive Belt Micro V	96-24752 and on	\$16.95
7235	Ground Drive Belt	92-12717 to 96-24751	\$21.12
7234-2	Blower Belt Micro V	07-89388 and on	\$16.60
7234-1	Blower Belt	01-52900 to 07-89387	\$16.40
7234	Blower Belt (3VX280)	92-12717 to 01-52899	\$9.80
6250-1	Drive Belt (3VX370)	14-124884 and on	\$14.98
6250	Drive Belt (3VX375)	02-57832 to 14-124883	\$15.19
6231	Drive Belt (3VX355)	92-12717 to 02-57831	\$11.95

# Deck & Catcher Parts

Order Number	Description	Price
5155-4	Gas Spring ( 10.0 Bushel Catcher)	\$19.97
5162-12	Roller Wheel 5" Poly	\$14.01
5162	Rubber Roller Wheel	\$12.18
7775-2	Hitch Pin / RH gold (#6)	\$4.08
7775-1	Hitch Pin / LH Silver (#6)	\$3.87
5052-1	LH Rotation ( Aluminum Gearbox)	\$211.60
5029-14	Oil Seal, Gear Box ( P007)	\$7.52
5740-2	Deck Pin Bushing 5/8	\$2.55



## CASTER FORK CAPS

Fits All Walker Mowers. Price  
Replaces Walker 8769-9 \$8.51 Each

## ROTARY BROOM 47 INCH

Order Number	Description	Each
I370	Wafer Brush Poly 18 Need 24	\$40.51
I370-1	Wafer Brush Steel Need 24	\$44.46
I362	100% Poly Broom Set 18"	\$699.78
I362-2	Brush Support	\$227.46



## Walker Mower Paint

Walker Gloss Yellow  
Used on all Walker  
Equipment  
12 oz Can

Order Number: 5866  
Price : \$24.79



## Walker Engine Oil

15W-50 Mobil One Oil  
Synthetic Oil, 1 Qt

Order Number: 122377  
Price : \$16.88  
6 or more  
Price : \$15.88 ea.



## Walker Gearbox Lube

Walker Hydro Gear Oil SHC 630

Order Number: 6450-20  
Price : \$33.00

5 Gallon Pail  
Order Number: 110843  
Price : \$349.00



## Walker Gearbox Lube

Mobile Lube 80W-90 Gear Lube

Order Number: 102508  
Price : \$14.88



# Dethatcher Parts

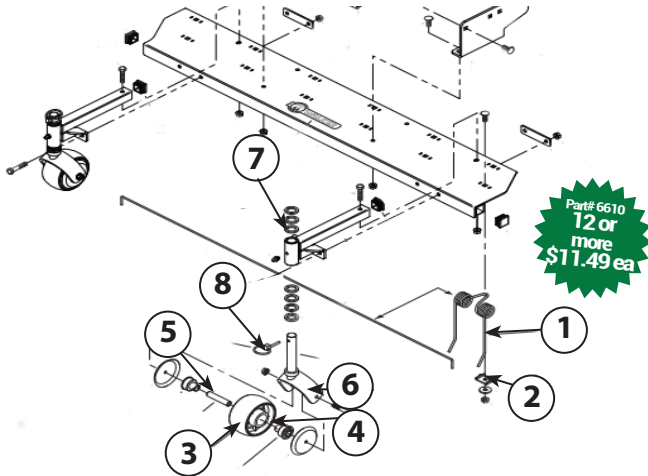

Part# 6610  
12 or more  
\$17.49 ea

	Order Number	Description	Price
1	6610	Dethatching Tine	\$12.49 (Need 12 per Rake)
2	6610-3	Tine Retainer Clip	\$3.33
3	6715-3	Roller Wheel Bearing	\$7.04
4	6715-2	Roller Wheel	\$7.00
5	6715-4	Axle Spacer Tube	\$12.36
6	6770	Caster Wheel Fork	\$43.61
7	6770-2	Spacer ( 1-1/8 x .765 x .125)	\$2.36
8	2775-1	Lynch Pin (3/16 x 1-1/4)	\$3.72

# WALKER Reuseable Dump Bag



2 or more  
\$69.99 ea.

Order Number 5598  
9.5 cu. Catcher Bag. Nylon bag  
Price \$74.95



2 or more  
\$79.99 ea.

Order Number 5598-2  
10.0 cu. Catcher Bag. Nylon bag  
Price \$85.95

## Walker Dethatcher

DT40A Dethatcher, Fits  
all Walker mowers. 40"  
Wide dethatcher.

Order Number: A10  
Price : \$799.99  
Wall Mount  
Order Number 6606-11 \$82.49





# WALKER Add-Ons

## Comfort Seat

- Standard on T23, T27i & B23i
- Replaceable Covers
- Optional armrests
- Available for all tractors ( Except Model H)
- Models T and D- 6104-8
- Models B, S, C -6104-9
- Model R - 6104-10
- Does not work with manual deck lift



6104-10 shown

**6104-8 \$559.99**   **6104-10 \$449.95**  
**6104-9 \$558.24**

## Standard Seat

- Standard on S, C, B18, B19 and R
- Large Contour molded seat
- Models S, B18 and B19 5103
- Models C 5103-3



**5103 \$229.00**  
**5103-3 \$239.99**

## Armrests

- Used for operator comfort and security
- Fold up when not in use
- Kit #5885 Fits Standard Seat
- Kit # 6104-6 Fits Comfort Seat

**5885 \$125.19**  
**6104-17 \$149.95**



## Headlights

- LED headlight with durable cast aluminum housing with 5 led lamps in each light
- Shock isolated mounting arm includes integral light guards
- 5989-14 Models
- 5989-13 Models B, C, H27i, H24d
- 7989-14 Models D & T
- 2989-12 Models H37i
- 5989-15 Models R

**5989-13 \$340.57**  
**7989-14 \$401.56**   **5989-14 \$236.06**  
**2989-12 \$142.70**   **5989-15 \$254.13**



## Instrument Panel Cover

- Protects Model D & T panel when parked outdoors or trailered in rain or snow.

**7307-2 \$155.26**



## Single Wide Tail Wheel

- Replaces standard dual tail wheel on Model T
- Not recommended for use on Model D or with Hi-Dump
- Great for a smooth cut look

**8049 \$290.37**



## Dual Tail Wheel

- Standard on Model T & D
- Two Independent tires
- Less turning resistance than single wide tail wheel.

**7420-20 \$356.68**



## Tail Wheel Lock

- Locking solenoid locks tail wheel into straight ahead position for striping and hill side work
- Controlled from toggle switch on forward speed control
- Manual override is accomplished by deliberately turning in either direction.
- Available for Models D & T

**8540 \$601.20**



## Spread Axle Tail Wheel

- Tail wheels on spread axle track behind drive tires and offer a smoother ride.
- Reduces maneuverability in tight spaces due to tail swinging out.
- Models C, D, T 7420-

Model D requires relocation kit 7420-8

**7420-3 \$813.00**  
**7420-8 \$79.58**



## Replaceable Wear Edge Kit

- Available on DC48 and DM52 decks
- Can be flipped over after being worn
- Can be replaced after both top and bottom edges are worn.
- Helps protect deck edges from curbs and walls.
- Each Kit includes 1 wear strip, 4 nuts and 4 bolts.
- For 48' Decks

**7703-10 \$39.95**





# WALKER



## Adjustable Footrests

- Adjustable footrest clamps on carrier frame of 36", 42, 48, C52 and S74 decks.
- Not compatible with deck height adjuster
- 8662-10 - 36, 42, 48, C52
- 8662-9 - S74

**8662-10 \$124.33**  
**8662-9 \$152.00**

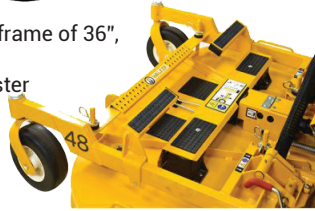

## Cup Holder

**Order Number: 5744-9**  
**Price : \$67.75**



Designed to fit any Walker mower. Mounts between Joystick. Easily retracts when deck is tilted up.



## Breakaway Blades

- Blades mount on break-away hub
- For use in mowing applications with more exposure to ground contact and debris.
- Minimizes blade damage and impact and shock loading on deck and drive train

5705-33 42" Deck 7705-8 48" Deck  
 5705-32 56" Deck 5705-34 74" Deck

**5705-33 \$273.82 | 7705-8 \$275.58**  
**5705-32 \$389.52 | 5705-34 \$499.59**

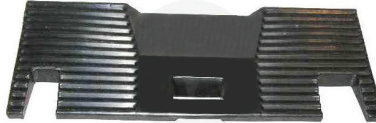

## Curb Jumper Ramp

Allows for Walker Mowers to Easily back over a standard curb for access to medians, parking areas and raised beds. Includes cut outs for deck height adjustment. Stows on Footrest

5597 Without Deck Height Adjuster  
 5597-1 with Deck Height Adjuster

**Order Number: 5597**  
**Price : \$319.95**

**Order Number: 5597-1**  
**Price : \$299.95**

## Deck Height Washers

- Allows fine adjustment of cutting height
- Finer adjustment than 1/2" increments
- 5727-1 (36, 42, 48, 52 and 56 gear drive deck) 1/4" thick
- 8727 (52, 62 and 74 belt drive deck) 1/4" thick

**5727-1 \$3.54 ea.**  
**8727 \$4.54 ea.**



## GHS Blower Lockout

- Disengages GHS blower on Models C, T, and D
- The Blower Lockout disengages the grass handling system blower to reduce noise and increase power when using a side discharge deck, mulching deck or PTO-driven attachment. Disengaging the blower also prevents grass, snow, or debris from entering the grass catcher.

**7541-1 \$59.51**

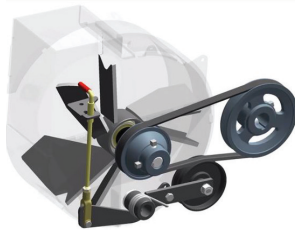

## Steering Lever Extensions

- Extend steering levers for easier reach
- This kit allows you to extend the length of the two steering levers, providing for easier reach and better maneuverability.

**5453-13 \$34.98**



## No-Catch Deflector

- Installed on catcher Door to convert GHS models to "no collection" rear discharge mowing.
- 8500-2 - 9.5/10.0 Bushel catcher
- 7500-2 - 7.0 Bushel Catcher

**8500-2 \$276.49**  
**7500-2 \$232.59**



## GHS Exhaust Screen Large Holes

- Use in wet conditions to help prevent the GHS from clogging and to boost vacuum action.
- Easily interchanges with standard screen
- 7512-13 - for 7.0 Bushel
- 7512-11 - for 10.0 Bushel

**7512-13 \$168.26**  
**7512-11 \$161.62**



## Removable Bins

- Two molded boxes split the weight of the larger catchers when dumping.
- Useful for single operator
- Fits 9.5 & 10 Bushel catchers
- 8510-11 Set Of Bins
- 8510-9 Left Side, 8510-10 Right Side

**8510-11 \$541.56**  
**8510-9 \$234.92**  
**8510-10 \$286.14**



**BUY NOW & PAY LATER**

**affirm**

PROPARTS DIRECT GIVES YOU THE OPTION TO BUY THE PARTS YOU NEED NOW AND PAY OVER TIME WITH AFFIRM. CHOOSE AFFIRM AT CHECKOUT TO APPLY FOR FIXED MONTHLY PAYMENT OPTIONS THAT FIT ANY BUDGET. \*SUBJECT TO ELIGIBILITY. PAYMENT OPTIONS THROUGH AFFIRM ARE PROVIDED BY THESE LENDING PARTNERS. AFFIRM.COM/LENDERS.

## OEM PARTS



### Scag Cup Holder

- Fits All Models
- Mounts on Side by Drive levers

**Order Number 920W**  
**Price \$68.00**



### Scag Blade Buddy

- Fits All Models
- Slides Over Blade, Stops Turning

**Order Number 921Z**  
**Price \$49.00**



Scag Flat Free Front Caster Tire & Wheel Assembly - Fits Fixed Deck W/B & STHM

**Order Number 9275**  
**Price \$89.00**



Scag Flat Free Front Caster Tire & Wheel Assembly - Fits SWU, SWZU, SZC and SFZ

**Order Number 9276**  
**Price \$88.00**



Scag Flat Free Front Caster Tire & Wheel Assembly - Fits V-Rides Size: 11 x 4.0

**Order Number 921D**  
**Price \$96.00**

## SCAG OEM OILS



Order Number	Description	Price
486257C	Chassis Grease	\$15.89
486258C	Spindle Grease	\$15.49
486254C	20W-50 Hydro 1 Gal	\$58.58
486255C	20W-50 Hydro 1 qt.	\$15.89
486256C	80W-90 Gear Lube	\$7.95

## SCAG QUICK PARTS BY MOWER



Scag SW Walk Behind

Order Number	Description	Price
48203	Transmission Belt	\$23.67
48202A	Wheel Belt	\$79.88
48278	32" Deck Belt	\$52.45
48089	36" Deck Belt	\$52.18
483518	48" Deck Belt	\$44.86
48087	36" RH Deck Belt	\$37.55
48285	48" RH Deck Belt	\$35.37



Scag Tiger Cat II

Order Number	Description	Price
485648	52" Pump Drive Belt	\$41.58
485649	61" Pump Drive Belt	\$40.48
483241	48" Deck Drive Belt LH	\$56.06
483242	52" Deck Drive Belt LH	\$68.73
485845	61" Deck Drive Belt LH	\$80.81
483239	48" Deck Drive Belt RH	\$27.04
483240	52" Deck Drive Belt RH	\$29.44
483157	61" Deck Drive Belt RH	\$49.52
48462-01	Hydro Filter	\$22.88



Scag SWZ Hydro Walk Behind

Order Number	Description	Price
48553	36" Pump Drive Belt	\$43.18
48553	48" Pump Drive Belt	\$43.18
48587	52" Pump Drive Belt	\$48.35
48587	61" Pump Drive Belt	\$48.35
48204	36" Deck Belt	\$34.83
48089	48" Deck Belt	\$52.18
483518	52" Deck Belt	\$44.86
48088	61" Deck Belt	\$59.41
48087	36" Deck Belt RH	\$59.41
48285	48" Deck Belt RH	\$35.37
48265	52" Deck Belt RH	\$34.46
48462-01	Hydro Filter	\$21.79



Scag Cheetah

Order Number	Description	Price
484372	Pump Drive Belt 48" / 52"	\$43.88
483316	Deck Belt 48"	\$28.89
482239	Deck Belt RH Side	\$31.63
483240	Deck Belt 52"	\$29.44
483165	Pump Drive Belt 61" / 72"	\$58.41
483741	Deck Belt 61"	\$69.71
483157	Deck Belt 61"	\$49.52
484088	Deck Belt 72"	\$92.45
484159	Deck Belt RH 72"	\$61.44
52114	Hydro Filter	\$16.95
71943	Hydro Filter	\$20.95



Scag SVR-V Ride II

Order Number	Description	Price
485902	36" Pump Drive Belt	\$24.95
483520	48" Pump Drive Belt	\$20.14
483520	52" Pump Drive Belt	\$20.14
483520	61" Pump Drive Belt	\$20.14
486023	36" Deck Belt	\$61.13
483966	48" Deck Belt	\$74.03
484100	52" Deck Belt	\$80.23
485880	61" Deck Belt	\$85.76
48462-01	Hydro Filter	\$21.79



Scag Turf Tiger II

Order Number	Description	Price
485909	Pump Drive Belt	\$66.73
485928	Pump Drive Belt (Diesel)	\$68.54
482876	PTO Belt	\$23.93
482281	52" Deck Belt	\$58.70
481558	61" Deck Belt	\$82.57
481980	Deck Belt	\$92.91
48758	Hydro Filter	\$22.89



**WE HAVE AVAILABLE  
100% OF THE PARTS!**



OEM Hurricane Blowers Parts for X3 and Z3 Stand-On Blowers. Hurricane was purchased by Briggs & Stratton last year and now Ferris and Billy Goat have versions of the stand-on blower. A lot of the part numbers are interchangeable. If you have the older Hurricane blower we have noted the old Hurricane part number and the new Ferris/Billy Goat part number.



Old Hurricane Part #	Billy Goat Reference	Order Number	Description	Each
106-17-3007	84001319	<b>G5107037</b>	Reversing Switch	\$42.50
101-17-5612	84001265	<b>G5106950FS</b>	Safety Switch	\$24.63
101-18-1802	84001267	<b>G5106953FS</b>	Left Deflector Motor	\$98.29
314-0618-255R	84001397	<b>G5106952FS</b>	Right Deflector Motor	\$98.29
0117-162024	84001260	<b>G5021541SM</b>	Plastic Bushing	\$10.28
ZP15017	84001573	<b>G5106821</b>	Drive Belt Z3	\$36.23
X3-A7227	84001546	<b>G5107258</b>	Drive Belt X3	\$52.89
425-1041-76010	84001471	<b>G5107194</b>	Throttle Choke cable Z3 & X3	\$31.64
425-103-174430	84001470	<b>G5107193</b>	Drive Dampener	\$57.72
16127	84001238	<b>G5106923</b>	Idler Spring Z3 & X3	\$11.11
17-4101	84001376	<b>G5107103</b>	Idler Pulley Engine to Drive	\$27.53
104-17-5608	84001302	<b>G1714054</b>	Ignition Key Set (2)	\$6.77
XP1745	84002320	<b>G5106813</b>	47.15 Raw Edge Belt	\$36.95
ZP1507	5106821	<b>G5106821</b>	Z3 Drive Belt	\$36.23
15128	84001203	<b>G5106888</b>	Extension Spring	\$3.38
104-17-5610		<b>G5107021</b>	Iginiyon Snap-In Switch	\$36.23
106-17-2806	5107034	<b>G5107034</b>	Switch Seal	\$14.73
106-17-2817		<b>G5107035</b>	Relay	\$20.04
ZP15027-5	84001578	<b>G5107048</b>	Caster Tire	\$99.54
314-17-4101	84001440	<b>G5107103</b>	Idelr Pulley 3 ID, .506 ID	\$27.53
17-4103		<b>G5107166</b>	Mule Drive Pulley	\$33.35
X3-A7227		<b>G5107258</b>	Belt Drive, Kohler Motor	\$52.89
X310-2042		<b>G5107339AAFS</b>	Universal Deflector Gear	\$54.34
ZP173007		<b>G5601265</b>	JoyStick Assm	\$289.00



The Impellers for Hurricane blowers have changed now that Billy Goat owns the company. You will have to measure your crankshaft to get the right one.

Used on certain Hurricane X3 Fits 1-7/16 Crankshaft Replaces X3-1637 Billy Goat 84001746  
**Order Number G5107448**  
**Price \$788.34**



Used on Hurricane Z3 2015 to Current Replaces ZF15018

**Order Number G5419590**  
**Price \$582.12**



**NOTE: G5107503**  
Impeller for X3 2014 to 2016 Replaces X310-203727 If Crankshaft is 1-7/16 use part G5107448. If Crankshaft is 1-1/8. Use Crank upgrade kit G5107259 (X3-CH70) and pulley G5107063



485691



486671



486838

## Nozzle Parts

Order Number	Description	Price
485691	Switch Plunger, Double Pole Nozzle Limit	\$10.37
486353	Nozzle Direction Switch	\$82.66
463534	Gear Drive Motor, Kit	\$877.75
486811	Nozzel Control Module	\$271.46
486838	Control Cable Air Direction (Replaces 486276)	\$90.89

Replaces  
486671



486265



462069



484721

## Electrical Parts

Order Number	Description	Price
484721	Tiger Eye, Cluster Gauge	\$336.45
485833	Switch, PTO Sealed	\$42.35
462069	Key Assy W/Fob	\$8.24
481182	Indicator Light (EFI Models Only)	\$42.23
48798	Key Switch	\$24.30
481637	N/O Switch	\$8.68
48717	Switch	\$8.93
486265	Clutch w/Tag GT3.5	\$576.64
486139	Wire Harness Adapter	\$22.20



484246



484286



484342

## Fuel System Parts

Order Number	Description	Price
484246	Fuel Gauge Assy, 16-1/2	\$78.54
484286	Fuel Cap Tethered	\$48.04
484342	Carbon Cannister, 550cc	\$91.06
486670	Muffler	\$153.20



481164



48462-01



485788

## Hydro Drive Parts

Order Number	Description	Price
481164	Hydro Tank Cap	\$16.15
48462-01	Hydro Filter	\$22.88
485788	Wheel Motor, SVR11	\$873.65
04063-25	Woodruff Key 5/16-1"	\$2.80
04021-19	Center Lock Nut 1/2-13	\$0.37
486265	Clutch GT3.5	\$605.47
483112	SMZC Deck Drive Spring	\$13.04
486322	Pump Drive Belt	\$28.22
483213	Pulley, 4.5 Dia Idler	\$47.25



486281



463312



486695

## Blower Housing Parts

Order Number	Description	Price
463312	Blower Housing w Decals	\$716.24
486281	Outlet Adapter, Impellar Housing	\$268.60
486695	Outlet Adapter, Nozzle Housing	\$189.95
485691	Plunger Switch, Double Pole	\$10.89
463534	Gear Drive Motor	\$877.75
9278	Caster Wheel	\$154.35



486323



486265



486324

## Gearbox Parts

Order Number	Description	Price
486324	Gearbox Output Belt	\$53.09
486265	Clutch, GT3.5	\$576.64
486323	Gearbox Input Belt	\$68.63
HG70525	Seal Kit	\$35.57





### Boom Arm Parts

Order Number	Description	Price
486150	Boom Arm Spring	\$33.36
463152	Nozzle Assembly RH	\$44.04
486699	Nozzle Assembly Main	\$44.04
463151	Nozzle Assembly LH	\$44.04
486557	Nozzle Strainer #50 Mesh	\$2.98
486100-01	Nozzle Tip	\$18.62
486098	Nozzle Cap	\$2.22
486097	Nozzle Body, Single LH	\$23.70
486700	Nozzle Body, Single RH	\$16.96
486090	12V Electric Pump	\$372.96
486186	Screen	\$56.99



### Body Parts

Order Number	Description	Price
486340	Grease Cap	\$11.94
481657-01	Cone Bearing	\$2.87
486109	Caster Wheel Assy, 16x6.50x8	\$193.92
484243	Fuel Gauge	\$72.15
484286	Tethered Fuel Cap	\$45.75
486470	Muffler, 21 HP BV	\$196.99
462999	Wheel Hub Assy	\$98.24
482639	Wheel Motor	\$817.42
48462-01	Oil Filter	\$22.88
486111	Pump Drive Belt	\$28.35
48680	Castle Nut	\$15.25
484754	Spring	\$16.46



### Hopper Parts

Order Number	Description	Price
486381	220 lb Hopper Cover	\$94.11
486390	Hopper Gate Cable	\$219.67
486439	Side Deflector Cable	\$217.88
486544	Pattern Adjust Cable	\$255.83
486373	Milled Dial	\$12.29
486541	Door Assist Spring	\$8.60
486440	Electric Motor Gear	\$496.39
486351	Impeller	\$60.27
486389	Rocker Switch	\$16.41
486455	Motor Controller	\$518.94



### Electrical

Order Number	Description	Price
483473	Double Pole Plunger Switch	\$14.97
462069	Key Assy w / Fob	\$8.24
486389	Rocker Switch	\$16.41
486621	Trail Tech Display	\$323.99



### Grease & Oils

Order Number	Description	Price
486257C	Chassis Grease	\$15.98
486258C	Spindle Grease	\$15.49
486254C	20W-50 Oil Gallon	\$58.58
486255C	20W-50 Oil Quart	\$15.89



### Kits & Accessories

Order Number	Description	Price
9612	SGSTS Foamer	\$1,157.00
9613	SGSTS Light Kit	\$227.00
9614	SGSTS 7 GPM Pump	\$444.00
9616	SGTST Rear Tray	\$69.00
9617	SGSTS Weight Kit	\$211.00



# Popular replacement Parts for Current and older Models

Be sure to check your serial number before ordering.  
Part below for models 2018 and newer



## Z-Spray Max



## Z-Spray Intermediate

Key Switch	135-6052	\$22.99
Hour Meter	135-5259	\$36.99
Striker Head Only	135-8900	\$139.99
Operation Switch	135-6121	\$51.99
Muffler	135-5685	\$250.99
Belt	135-5664	\$34.99
Throttle Cable	135-5260	\$35.99
Choke Cable	135-5707	\$35.99
Fuel tank / Cap	135-7172	\$179.99
Large Hopper cover	135-7981	\$48.39
Hopper	135-5985	\$308.99
Dial	126-0988	\$7.95
Cable Push/Pull	135-5931	\$41.99
Hose Reel	135-5787	\$307.99
Spot Spray Gun	135-5773	\$50.99
Left tank Asm	135-5917	\$356.99
Hydraulic Filter	142-3049	\$33.99
Tandem Pump	135-5665	\$1,379.99
RH Wheel Motor	135-5231	\$530.99
LH Wheel Motor	135-5230	\$530.99
Chrome Valve	135-5760	\$22.99
5.0 GPM Pump	142-3321	\$281.99
Caster Locking cable	135-5644	\$79.99
Foot Plate Spring	135-5654	\$14.99
Directional Valve	135-5721	\$62.63
Gauge	142-3437	\$26.99
Hose Barb	120-8671	\$1.89
Body Nozzle Left	135-5788	\$8.99
Body Nozzle Center	135-5789	\$8.99
Body Nozzle Right	135-5790	\$8.99
RT Tank Asm	135-5918	\$356.99
Spray Tank cap	135-5916	\$7.79
Front Caster Wheel & Tire	135-5974	\$126.99
Cone Bearing	1-633585	\$17.99
Seal	103-0063	\$7.79
LH Caster Fork	135-5441-05	\$152.99
RH Caster Fork	135-5446-05	\$152.99
Fork Cone Bearing	254-92	\$14.50
Grease Seal	1-543511	\$10.59
Dust Cap rubber	135-5756	\$2.19
Solenoid	135-6189	\$27.89

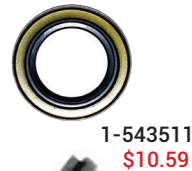

Nozzle Left	135-5788	\$8.99
Nozzle Right	135-5790	\$8.99
Hour Meter	135-5259	\$36.99
Key Switch	135-6052	\$22.89
Rocker Switch	100-8469	\$21.01
Striker Head Only	135-8900	\$139.99
Operators Switch	135-6121	\$51.99
Solenoid	135-6189	\$27.89
Muffler	135-5685	\$250.99
Belt	135-5664	\$34.99
Throttle Cable	135-5260	\$35.99
Choke Cable	135-5707	\$35.99
Fuel Tank Asm / W Cap	135-7172	\$179.99
Large Hopper Cover	135-7981	\$48.39
Hopper	135-5985	\$308.99
Dial (126-0988)	142-3319	\$2.19
Dial Mount	126-0985	\$3.48
Spinner (135-5954)	142-3506	\$32.99
Push /Pull Cable	135-5931	\$41.99
Push/Pull Cable	135-5935	\$83.99
Hose Reel	135-5787	\$307.99
LT Tank Asm	135-5993	\$299.99
Tank Cap	135-5916	\$7.79
Spot Spray Gun	135-5773	\$50.99
LH Wheel Motor	135-5230	\$530.99
RH Wheel Motor	135-5231	\$530.99
Tandem Pump	135-5665	\$1,379.99
Hydraulic Filter	142-3049	\$33.49
5.0 GPM Pump	142-3321	\$281.99
Chrome Valve	135-5760	\$22.99
Caster Locking Cable	135-5644	\$79.99
Directional Valve	135-5721	\$53.04
Gauge	142-3437	\$26.99
Hose Barb	120-8671	\$1.89
RH Tank Asm	135-5995	\$299.99
Strainer	135-5765	\$20.99
Caster Wheel & Tire (135-5974)	142-5509	\$126.99
Wheel Cone Bearing	1-633585	\$17.99
Seal	103-0063	\$7.79
LH Caster Fork	135-5441-05	\$152.99
RH Caster Fork	135-5446-05	\$152.99

**Z-Spray Parts are Now In-stock for MAX , Intermediate and Junior Models. For models 2017 and older give us a call or visit our website.**



### Z-Spray Junior

Nozzle Left	135-5788	\$8.99
Nozzle Right	135-5790	\$8.99
Hour Meter	135-5259	\$36.99
Key Switch	135-6052	\$22.99
Rocker Switch	100-8469	\$21.01
Striker Head Only	135-8900	\$139.99
Operators Switch	135-6121	\$51.99
Solenoid	135-6189	\$27.99
Muffler	135-5685	\$250.99
Belt	135-5664	\$34.99
Throttle Cable	135-5260	\$35.99
Choke Cable	135-5707	\$35.99
Fuel Tank Asm / W Cap	135-7172	\$179.99
Large Hopper Cover	135-7981	\$48.99
Hopper 150lb	135-6010	\$268.99
Dial	126-0988	\$7.95
Dial Mount (126-0985)	142-3319	\$2.19
Spinner (135-5954)	142-3506	\$32.99
Push /Pull Cable	135-5931	\$41.99
Push/Pull Cable	135-5935	\$83.99
Hose Reel	135-5787	\$307.99
LT Tank Asm	135-5993	\$299.99
Tank Cap	135-5916	\$7.79
Spot Spray Gun	135-5773	\$50.99
LH Wheel Motor	135-5230	\$530.99
RH Wheel Motor	135-5231	\$530.99
Tandem Pump	135-5665	\$1,379.99
Hydraulic Filter	142-3049	\$33.49
5.0 GPM Pump	142-3321	\$281.99
Chrome Valve	135-5760	\$22.99
Caster Locking Cable	135-5644	\$79.99
Directional Valve	135-5721	\$62.63
Gauge	142-3437	\$26.99
Hose Barb	120-8671	\$1.89
RH Tank Asm	135-5995	\$299.99
Strainer	135-5765	\$20.99
Caster Wheel & Tire	142-5509	\$126.99
Wheel Cone Bearing	1-633585	\$17.99
Seal	103-0063	\$7.79
LH Caster Fork	135-5441-05	\$152.99
RH Caster Fork	135-5446-05	\$152.99



### Z-Spray LTS

Manifold Valve Control	135-6362	\$361.99
Ignition Switch	126-6285	\$38.99
Rocker Switch	100-1535	\$72.45
Safety Switch	82-2190	\$12.99
Throttle Control	135-3149	\$37.99
Push/Pull Cable	135-3150	\$30.99
Transaxle	126-2814	\$1,667.99
7 Inch Fan	126-2980	\$16.99
Center Knee Pad	142-2751	\$68.99
Left Nozzle Asm	126-3667	\$64.99
Right Nozzle Asm	126-3669	\$64.99
Frame Bearing	126-3008	\$17.99

Side Deflector (126-1217)	142-3619	\$54.99
3.8 Gpm Pump	142-2301	\$399.99
Hopper Screen Small	126-3242	\$180.99
Spreader Motor	126-6231	\$503.99
Water Cap	126-0285	\$16.99
Front Axle	126-6733	\$252.99
Wheel & Tire Asm	142-2736	\$132.99
Wheel Bearing	116-0720	\$18.99
Motion Cable	126-2169	\$162.99
Rod End Steering	126-7181	\$60.99
Rod End LH	126-7182	\$60.99
Strainer	126-4374	\$48.99

**The Fastest Moving Parts!  
Don't See What you need?  
Give us a call  
800 305 9255**

Check Us Out online for Calibration specs, older manuals and Installation Instructions on Tanks and Kits!

### Z-Spray Aerator

Hydraulic Filter	142-3049	\$33.49
Choke Cable	135-5707	\$35.99
Hour Meter	135-5259	\$36.99
Key Switch	135-7094	\$27.99
Striker Head	135-8900	\$139.99
Muffler	135-9252	\$141.99
RH Pump	135-9026	\$706.99
LH Pump	135-9024	\$776.99
LH Caster Fork	142-0300-05	\$143.99
Wheel & Tire	135-8615	\$78.13
Axle - Screw	135-6300	\$10.99
RH Caster Fork	142-0301-05	\$143.99
Drive Belt	135-9075	\$55.99



Reel Tine	135-9387-05	\$159.99
Tine Coring	126-2143	\$9.99
Pillow Block Bearing	135-9379	\$20.99
Caster Locking Cable	135-8632	\$97.99
Lift Cylinder	135-9157	\$239.99

### Spray Tips

Mixing of liquid or dry product should be in accordance to manufactureres labels. Remember that the Z-Spray is designed for low volume spraying so the mix will be more concentrated.



Green Tip 1/5 Spray Tip Order Number: 135-8285 Price: \$20.99	Yellow Tip 1/4 Spray Tip Order Number: 142-3307 Price: \$20.99	Violet Tip 1/3 Spray Tip Order Number: 142-3308 Price: \$18.99	Blue Tip 2/5 Spray Tip Order Number: 135-8283 Price: \$16.32	Red Tip 1/2 Spray Tip Order Number: 142-3310 Price: \$15.99	Brown Tip 3/4 Spray Tip Order Number: 135-8284 Price: \$19.99
---	--	--	--	---	---

### WRIGHT WHEEL MOTORS

Can be model specific. Please verify with serial number before ordering.



Order Number	Description	Used On	Price	Order Number	Description	Used On	Price
32410001	Hydro Motor MF 1606	WS	\$720.69	32410010	Hydro Motor P Bearing Kit	WS32, WS36	\$182.69
32410002	Hydro Motor MF 1409	WS	\$911.99	32410011	Hydro Motor 15H HGM	WSZK	\$1,102.99
32410003	Hydro Motor 1209	WS, WSE	\$899.99	32410012	Hydro Motor 15H HGM	WSZK	\$1,102.99
32410004	Hydro Motor 12P	WS32, WS36	\$699.00	32410013	Hydro Motor P Seal Kit	WS32, WS36	\$191.99
32410005	Hydro Motor 15E	WSE, WSZK, WZ	\$1,078.99	32410018	Hydro Motor E Seal Kit		\$191.99
32410007	Hydro Motor	WS	\$769.00	32410022	Hydro Motor 12P		\$759.99
32410009	Hydro Motor P Seal K		\$191.99	32410023	Hydro Motor 15P		\$769.99



Order Number 34490002  
Used on Wright Mowers



Order Number 39410007  
Used on Wright B mowers & ZXL mowers. For ZT-3400

### POPULAR WRIGHT MOWER PARTS





As Needed per Bulletin SVC-TSB-0115

Order Number	Description	Price	Order Number	Description	Price	Order Number	Description	Price
71410001	Electric Clutch	\$475.99	71460136	Spindle	\$249.95	95460028	Spindle Kit	\$36.99





Used on WSE48/52/61/36/42 Mowers      WRIGHT OEM PAINT      Used on WS32 /WS36 Mowers

Order Number	Description	Price	Order Number	Description	Price	Order Number	Description	Price
71460207	Spindle	\$249.99	93990003	Wright Paint	\$25.99	52410003	Safety Switch	\$14.99





Used on WS32 /WS36 Mowers

Order Number	Description	Price	Order Number	Description	Price	Order Number	Description	Price
71460004	Spindle Pulley	\$90.99	53490019	Relay	\$16.99	71460006	Idler Pulley	\$38.84





Used on WS32 Fixed Deck

Order Number	Description	Price	Order Number	Description	Price	Order Number	Description	Price
72490003	Wheel Plastic	\$18.89	14990003	Bronze Bushing	\$15.99	14990001	Pivot Bushing	\$12.59





Order Number	Description	Price	Order Number	Description	Price	Order Number	Description	Price
18410012	Knob Plastic	\$9.99	17460023	Dust Cap	\$8.99	71460009	Idler Pulley	\$42.99





Used on WVG/WVH Models

Order Number	Description	Price	Order Number	Description	Price	Order Number	Description	Price
52420002	Throttle	\$31.49	52420003	Blade Switch	\$34.64	71460131	Spindle	\$237.99



### Wright Commercial Mower Belts

Order Number	Price
71460001	<b>\$45.99</b>
71460002	<b>\$51.99</b>
71460003	<b>\$69.99</b>
71460010	<b>\$50.99</b>
71460011	<b>\$64.99</b>
71460012	<b>\$56.99</b>
71460013	<b>\$75.99</b>
71460034	<b>\$51.99</b>
71460040	<b>\$98.99</b>
71460062	<b>\$65.99</b>
71460063	<b>\$62.99</b>
71460064	<b>\$58.99</b>
71460065	<b>\$53.99</b>
71460066	<b>\$49.99</b>
71460067	<b>\$59.99</b>
71460070	<b>\$49.99</b>
71460071	<b>\$93.99</b>
71460087	<b>\$91.99</b>
71460095	<b>\$40.99</b>

### NORTHERN GRASS BAFFLE KIT

Description	Order Number	Price
52" Baffle Kit	98440015	<b>\$349.99</b>
62" Baffle Kit	98450014	<b>\$359.99</b>

# Wright Mulch Kits

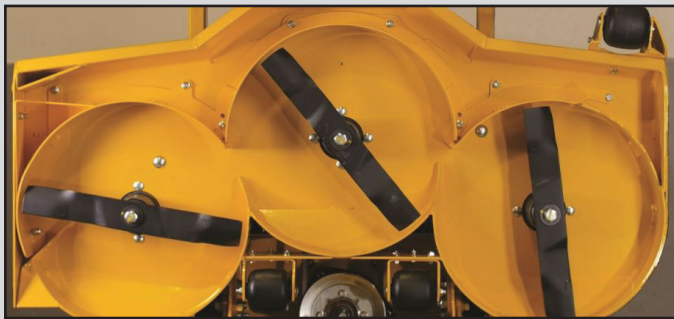

Mulch kits are a great alternative to collecting clippings and leaves. The recirculating baffles break down clippings into small and easily biodegradable pieces.

Deck Size	Aero Core Deck	Price	Reg 5" Deck	Price	
32	95460029	<b>\$329.99</b>	95480003	<b>\$329.99</b>	
36	95480005	<b>\$329.99</b>	95470002	<b>\$329.99</b>	
42	95480006	<b>\$329.99</b>	95480002	<b>\$329.99</b>	
48	95430009	<b>\$349.99</b>	95430003	<b>\$349.99</b>	
52	95440011	<b>\$389.99</b>	95440003	<b>\$349.99</b>	
61	95450011	<b>\$359.99</b>	95450003	<b>\$359.99</b>	
72	98460069	<b>\$379.99</b>	98460069	<b>\$379.99</b>	
<b>Stander B</b>					
32	95460030	<b>\$329.99</b>	48	95430009	<b>\$349.99</b>
36	95460031	<b>\$329.99</b>	52	95440011	<b>\$389.99</b>



## Trimmer Holder

- Fits All Wright Stander Models
- Mounts trimmer right on mower
- Good for single Operator

**Order Number**  
**98470106**  
**Price \$99.95 ea.**



## Jack Socket Bracket

- Fits All Wright Models
- Allows For jack to be mounted to front of mower

**Order Number**  
**95410047**  
**Price \$99.00 ea.**

\* Does not include jack



## Add-ons and Accessories

# MICHELIN® TWEEL TIRE



The Newest in Tire Innovation. Leaves a light foot print and last **10x** longer than regular tires.

Mower	Size	Order Number	Price
Stander I / Sport I	18.5	72410097	<b>\$449.00</b>
Stander X / Sport X	18.5	72410097	<b>\$449.00</b>
ZK 61" & 72"	24	72410098	<b>\$689.00</b>
ZK 52"	24	72410110	<b>\$729.95</b>
ZXT 52"	26	72410103	<b>\$789.95</b>
ZXT 61" & 72"	26	72410104	<b>\$796.00</b>
ZK 72"	Dual Tweel	95410048	<b>\$2,999.00</b>
ZXT 72"	Dual Tweel	95410050	<b>\$3,599.00</b>
ZK 72"	Dual Wheel	95410045	<b>\$1,300.00</b>
ZXT 72"	Dual Wheel	95410051	<b>\$1,500.00</b>

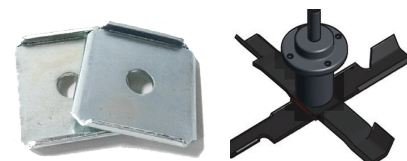

## X-Blade Adapter Kit

- Fits All Wright Models
  - Allows dual blades and creates finer clippings
- Package of 2      Package of 3
- Order Number XB2-5/8**      **Order Number XB3-5/8**  
**Price \$21.49 ea.**      **Price \$31.49 ea.**



## ZK ADD-ONS

Add-ons for the Stander ZK

Description	Order Number	Price
ZK Tractor Weight kit, 100 lbs	95410044	<b>\$486.99</b>
Dual Wheel Kit	95410045	<b>\$1,300.00</b>



## STANDER B ADD-ONS

Add-ons for the Stander B

Description	Order Number	Price
Bag Kit	95490020	<b>\$129.99</b>
Stripe Kit	98460074	<b>\$119.95</b>

## ADDITIONAL PARTS

Additional parts for servicing and other accessories



Description	Order Number	Price
Hydro Filter	34490002	<b>\$22.95</b>
15W-50 Hydro Oil	36490013	<b>\$15.48</b>
Easy on / Off Block Plate	93460215	<b>\$105.99</b>
Fire Extinguisher Bracket	98490021	<b>\$89.99</b>
Light Bar Bracket*	98490023	<b>\$49.00</b>

\* Light bar not included



## COLLECTION BAG

Nylon Mesh Trash Collections bags

Description	Order Number	Price
Stander X / WSTX/WSLG	95490014	\$129.99
Stander I / WSTN / WSS	95490015	\$129.99
Velke HC / WVLC/WVGC	95490016	\$129.99
WSZK	95490017	\$129.99

# Dingo Tracks



Order Number	Description	Price
136-5847	Track - STD Tread - Fits TX222, TX320 and TX420	\$649.95
108-5640	Narrow Track - Aggressive tread - Fits TX222, TX220, TX320, TX420	\$848.00
136-5848	Wide Track - Fits TX425, TX525 and TX427	\$749.95
112-4816	Rubber Track - Fits TRX15, TRX19, TRX16, TRX20	\$495.00
136-5845	Wide Track - Fits TX-1000	\$980.00
136-5846	Narrow Track - Fits TX-1000	\$749.00
110-0069	Track Alignment Tool	\$299.95
108-9749	Aggressive Wide Track Fits TX425 & TX525	\$942.00
138-0804	Narrow Track For TX-1000 (22327, 22351) Sprocket Driven	\$899.95



## Dingo Track Alternatives

Due to limited supply on Tracks from Toro, we sourced a quality track that can replace a few Toro Dingo tracks. This high quality track is also used on machines from Bobcat, Cat and New Holland.

Order Number	Description	Price
153X28X89SNX	Replaces 136-5847	\$319.95
240X28X87.63SNX	Replaces 136-5848	\$479.95
240X37X87.63SNX	Replaces 136-5845	\$549.95
152X22X89SNX	Replaces 112-4816	\$279.95

## Quick Attach Plate **Order Number: 132-8418**

Toro Dingo Quick Attach Plate. Used to mount attachments to all Dingos.

**Price: \$1,219.95**



## Dingo Track Parts



Order Number	Description	Price
138-0782	Narrow Track Road Wheel Includes Bearing, Seal, Snap Ring and Cap	\$49.95
106-7620	Narrow Track Road Wheel - Includes Bearing	\$50.95
120-5378	Dingo Bearing For 106-7620 & 106-7621 Wheel	\$13.89
105-0248	Wide Track Road Wheel Kit Includes Bearing, Seal, Snap Ring and Cap	\$78.00
117-1310-03-OP	Guide Track Kit - Fits Models 22321, 22323, 22342	\$468.95
104-6123	Wheel Tensioner Assembly- Fits 22334, 22322, 22320 and 22307	\$338.00
138-1421	Road Wheel Asm, Fits TX-1000 Replaces 125-0431	\$249.95



Order Number	Description	Price
63-8300	Spin On Diesel Fuel / Water Filter	\$26.95
115-8189	Filter	\$15.49
99-3198	Inner Filter	\$40.95
99-3173	Air Filter	\$41.70
115-5304	Gas Cap	\$23.84
104-7418	Gas Cap	\$32.59
100-1854	Glow Plug	\$58.49

## Dingo Filter Kits

<p><b>TX427 Models 22321 &amp; 22322</b></p> <p>50 / 200 Hour Kit Includes: Air Filter 108-3811 Engine Oil Filter 115-8189 Hydro Filter 86-3010</p> <p><b>Order Number 136-4774</b> <b>Price: \$39.55</b></p>	<p><b>TX525 Models 22323 &amp; 22324</b></p> <p>50 Hour Kit Includes: Air Filter 108-3811 Engine Oil Filter 115-8189</p> <p><b>Order Number 136-4772</b> <b>Price: \$32.55</b></p>
<p><b>TX525 Models 22323 &amp; 22324</b></p> <p>200 Hour Kit Includes: Air Filter 108-3811 Engine Oil Filter 115-8189 Hydro Filter 86-3010 Inline Filter 112-7836 Fuel Spin-on 63-8300</p> <p><b>Order Number 136-4773</b> <b>Price: \$86.00</b></p>	<p><b>TX1000 Models 22327 &amp; 22328</b></p> <p>200 Hour Kit Includes: Air Filter 108-3811 Engine Oil Filter 104-5169 Hydro Filter 86-3010 Inline Filter 112-7836 Fuel Spin-on 63-8300</p> <p><b>Order Number 136-4771</b> <b>Price: \$85.49</b></p>
<p><b>TX1000 Models 22327 &amp; 22328</b></p> <p>50 Hour Kit Includes: Air Filter 108-3811 Engine Oil Filter 104-5169</p> <p><b>Order Number 136-4770</b> <b>Price: \$32.00</b></p>	<p><b>TRX-26 STX Models 22974 &amp; 23208</b></p> <p>50 Hour Kit Includes: Air Filter 119-5944 Engine Oil Filter 119-5852</p> <p><b>Order Number 137-3816</b> <b>Price: \$47.00</b></p>
<p><b>TRX-16 &amp; 20 Models 22972 &amp; 22973</b></p> <p>50 Hour Kit Includes: Air Filter 120-7448 Engine Oil Filter 119-5852</p> <p><b>Order Number 137-3815</b> <b>Price: \$43.95</b></p>	<div style="text-align: center;"> <p><b>BUY NOW &amp; PAY LATER</b></p> <p>PROPARTS DIRECT GIVES YOU THE OPTION TO BUY THE PARTS YOU NEED NOW AND PAY OVER TIME WITH AFFIRM.</p> <p>CHOOSE AFFIRM AT CHECKOUT TO APPLY FOR FIXED MONTHLY PAYMENT OPTIONS THAT FIT ANY BUDGET.</p> <p>*SUBJECT TO ELIGIBILITY. PAYMENT OPTIONS THROUGH AFFIRM ARE PROVIDED BY THESE LENDING PARTNERS. AFFIRM.COM/LENDERS.</p> </div>



# Dingo Compact Utility Loaders



## Mufflers

Order Number	Description	Price
105-0249	Muffler Fits TX420, TX425 and TX427	\$389.95
105-8381	Muffler Fits TX222, TX322, TX220, TX323, TX525N	\$297.28
117-1828	Muffler Fits TX320-D Model 22303	\$349.95
98-2759	Muffler Fits TX420 model 22306	\$539.95
106-9584	Muffler Fits TX525	\$399.95
99-8343	Muffler Gasket Fits TX220 and TX 525	\$7.19
25 041 17-S	Muffler Gasket Fits TX 222, 322, 420, 425, 413, 220, 323	\$3.76
138-0753	Diesel Muffler Fits TX-1000 Models 22327 & 22328	\$345.00
98-2761	Manifold Cross over	\$127.00
2112-11	Clamp	\$6.60

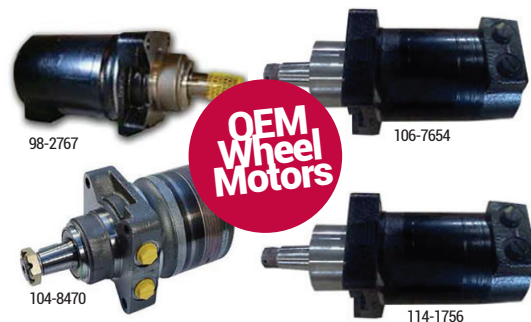

**OEM Wheel Motors**

## DINGO WHEEL MOTORS

Order Number	Description	Price
98-2767	Wheel Motor Fits 22306 & 22307 (200000-2400003000)	\$1,499.95
106-7654	Wheel Motor Fits TX 420, TX-425, TX-525, TX-427 (240000301 & up)	\$1,539.95
114-1756	Wheel Motor 22307, 22320, 22322 & 22324 (2007 & up)	\$1,699.95
104-8470	Wheel Motor 22308, 22330, 22970, 22971, 22972, 22973, 22974 / TRX( 2400000 and up)	\$1,658.49
99-3052	Wheel Motor Fits 22303, 22304, 22305, 22311, 22312, 22317, 22318, 22336, 22337 ( 2100000 and Up)	\$1,499.95
138-0778	Right Side Fits TX-1000 Models 22327, 22328, 22328HD	\$1,225.95
138-0761	Left Side Fits TX-1000 Models 22327, 22328	\$1,225.95



## Trencher Nose Sprocket

Roller Assembly - Includes Roller Nose and Bearings

Order Number 107-9325  
Price: \$338.00



## Auger Teeth 6" to 30" Augers

Order Number	Description	Price
104-5998	Tooth Wisdom	\$348.82
107-9314	Pilot Auger	\$68.00
104-5996	Carbide Tooth (W)	\$49.68
107-9312	Inner Tooth	\$16.21
104-5997	Chisel Tooth	\$47.33
107-9313	Outer Tooth	\$19.53

## ROTARY BROOM BRUSHES



Order Number	Description	Order Price
94-7372	Poly Brush Element	\$29.95
95-5942	Wire Brush Element	\$42.00

107-9312



107-9313



## Aerator Tine Pack Kit

Includes: 24 tines 126-2143  
Fits models:  
23515 21" Single Hydraulic Aerator (Takes 36 tines)  
23516 18" Mechanical Aerator (Takes 24 tines)  
29517 24" Stand-On Aerator (Takes 36 tines)  
29519 30" Stand-On Aerator (Takes 48 tines)

Price: \$182.00

Single 126-2143 Price: \$9.99 ea.



Order Number: 138-0758

## Soil Cultivator Pack Kit

Includes: All rotor blades required to update your machine.  
10 left blades of 114-7800, 10 right blades of 114-7801  
Fits models:  
23102 Soil Cultivator, Compact Utility Loader

Price: \$558.00

Single 114-7800 Price: \$29.75 ea.  
Single 114-7801 Price: \$29.75 ea.

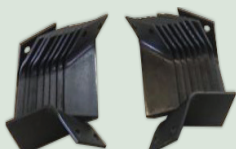

Order Number: 138-0759

## 40" Tiller Tine Pack Kit

Includes: All tines required to update your machine.  
18 left blades of 104-2044, 18 right blades of 104-2043  
Fits models:  
22445 45" Tiller, Compact Utility Loader

Price: \$529.00

Single 104-2044 Price: \$16.21 ea.  
Single 104-2043 Price: \$16.21 ea.



Order Number: 138-0760



Order Number	Description	Price Each	12 or more
114-4713	HYPRO-OIL 500 Hydro Oil 1 Qt.	\$12.99	\$12.00 each
114-4714	HYPRO-OIL 500 Hydro Oil 1 Gal.	\$49.99	

## Toro Dingo Tire and Rim Assemblies

### Left Hand Rim & Tire Assembly

Fits Dingo Models: 22300, 22302, 22303, 22304, 22305, 22311, 22312, 22317, 22318  
Includes Rim and Tire, replaces 98-2747

Order Number 144-2575 Price: \$237.00



### Right Hand Rim & Tire Assembly

Fits Dingo Models: 22300, 22302, 22303, 22305, 22311, 22312, 22317, 22318  
Includes Rim and Tire, Replaces 99-1447

Order Number 144-2574 Price: \$237.00



Lug Nut  
Order Number  
242-50  
Price: \$1.93 ea.

# SEE WHY OVER 68,000 LANDSCAPERS CHOOSE PROPARTS

**ProParts Direct**  
288 N. Broadway  
Salem, NH 03079



**Z-SPRAY PARTS ARE NOW IN-STOCK!**  
See Page 58-59

**Toro Dingo Wheel Motors**  
Starting at \$1,499.95

Order Number 98-2767  
Wheel Motor  
Fits 22306 & 22307  
(200000-2400003000)



**WALKER HYDRO STATIC DRIVES**  
Used on Walker MT, MD and MS tractors  
Starting at \$1,079.95



5025/5026

Follow Us On For Specials and giveaways through out the year

SHOP ONLINE AT  
[www.propartsdirect.net](http://www.propartsdirect.net)

Prices subject to change without notice. Not responsible for mis-print or typographical errors. Current catalog prices supersede all other. Printed prices expire on 7/31/2024

Visit Us Online at [www.propartsdirect.net](http://www.propartsdirect.net)  
Create an account and enjoy ProParts pricing all year long!

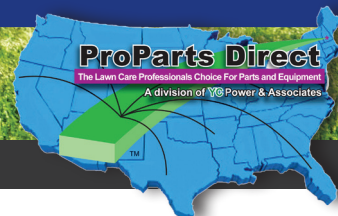

**Need Help? Call us at 800 305 9255**

**RIGHT PART, RIGHT PRICE . . . . . EVERY**

SHOP US FOR THESE MAJOR BRANDS . . . AND MORE!



ProParts Direct Catalog is for the landscape community. For old & new landscapers we pride ourselves on fostering the growth of this community. We thank @mowerman1s on his submission of photos for this years catalog. @mowerman1s is in no way a paid sponsor and we encourage you to follow his channel and others who have used our services.



**Now for Some Of the Details**  
SHOP ONLINE 24 HOURS A DAY,  
7 DAYS A WEEK  
Visit: [www.propartsdirect.net](http://www.propartsdirect.net)

Visit our website and place your orders in the shopping cart. All online orders are shipped within 3 to 5 business days. Online orders are confirmed via e-mail.

See Website for:



Venmo  
Apple Pay  
Google Pay  
Samsung pay



**BUY NOW & PAY LATER**  
CHOOSE AFFIRM AT CHECKOUT FOR ANY PURCHASE TO PAY OVER TIME IN FIXED MONTHLY INSTALLMENTS

ProParts Direct can save you money on high quality replacement parts and engines, keeping you and your crew running!

We have been serving the professional lawn industry for over 85 years.

**FACTORY TRAINED, AND READY TO HELP**

Our Call Center is staffed with over 50 years of experience. We are courteous & hands-on experts are ready to solve your parts questions.

**Shipping Policy**

\* Ventrac Sold In New England Only

Most Items will be shipped at regular shipping rates. Please see website for details.

Heavy or oversized items have special shipping rates – refer to our Shipping Oversized Items / Freight policy online. You can also email us with your address & telephone number and the items you are looking to order, so we can contact you with an accurate quote on Freight items.

Call us with questions regarding shipping at 800 305 9255