

Walker Rider Lawnmowers

MODEL MS36-42 (11-HP)

MODEL MC36-54 (16-HP)

OWNER'S MANUAL

Assembly, Safety, Operating and Maintenance Instructions

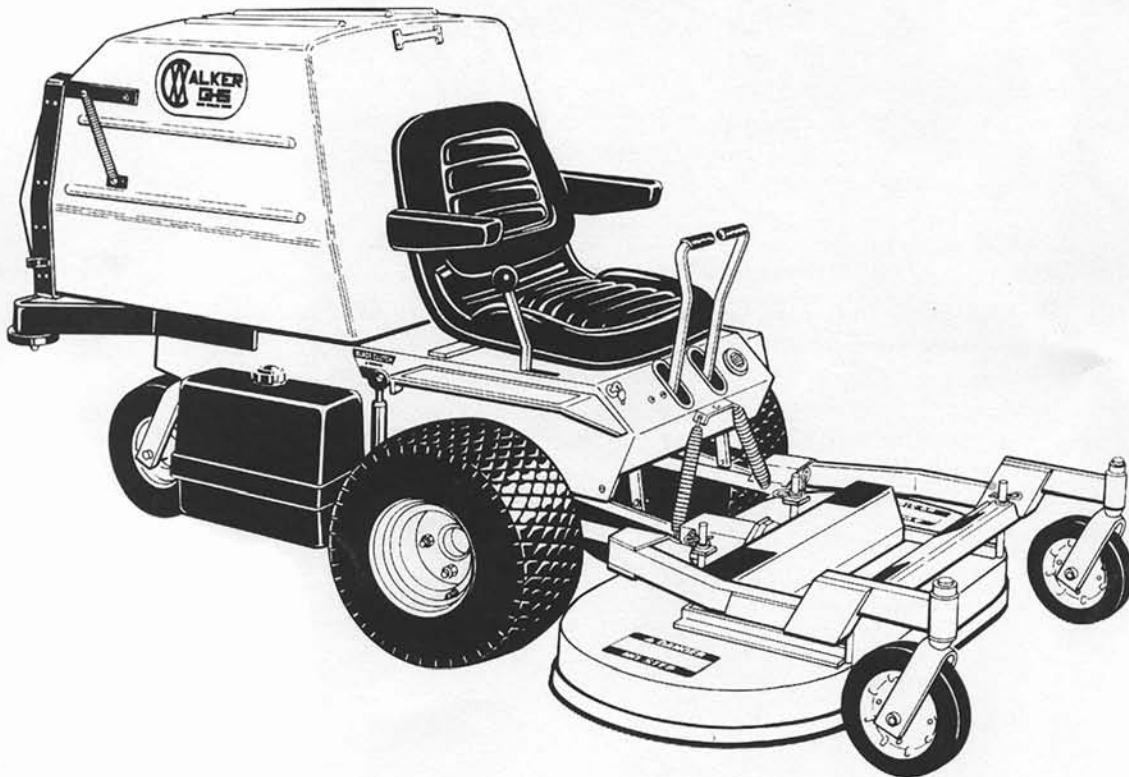

Please Read and Save These Instructions

For Safety, Read All Safety and Operating
Instructions Prior To Operating Machine

P/N 5895
Price \$5.00

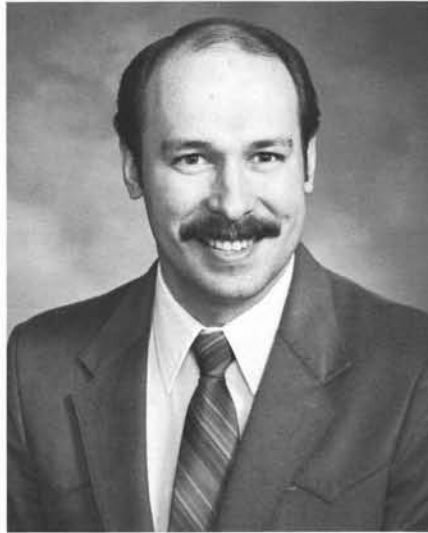

Dear Walker Mower Owner:

We at Walker Manufacturing Company want to thank you for becoming one of our customers. Every owner is important to us. We have worked hard to develop and produce a machine that will serve the needs of our customers. With proper care, the machine should provide many hours of dependable operation, giving real value for your investment.

We are concerned about the proper use and safe operation of the mower. Please have each operator carefully read all of the **safety and operating instructions before using the mower.** Like any piece of machinery, the mower will require maintenance and this manual contains complete instructions for proper care.

Our goal is for every customer to be completely satisfied. If you have any questions or problems in operating or servicing the mower, contact the dealer who sold you the machine. For further assistance, please write or call us at the factory. We want to support our customers with first-rate service and will do our best to see that you get it.

Sincerely,

WALKER MANUFACTURING COMPANY

A handwritten signature in cursive script that reads "Bob Walker".

Bob Walker, President

TABLE OF CONTENTS

SECTION 1 *General Information*

| | |
|----------------------------------------------------------------|---|
| HIGHLIGHTED INFORMATION | 2 |
| IDENTIFYING NUMBER LOCATION | 2 |
| SERVICING OF ENGINE AND DRIVETRAIN COMPONENTS | 2 |
| SPECIFICATIONS | |
| Standard 11-HP Model | 3 |
| Commercial 16-HP Model | 3 |

SECTION 2 *Safety Instructions*

| | |
|-------------------------------|----|
| BEFORE OPERATING | 7 |
| OPERATING | 8 |
| MAINTENANCE | 8 |
| SAFETY DECALS | 10 |

SECTION 3 *Assembly Instructions*

| | |
|--------------------------------------|----|
| SET-UP INSTRUCTIONS | |
| Install Tires | 11 |
| Service Battery | 11 |
| Assemble Mower Deck | 12 |
| Install Mower Deck | 13 |
| Level Mower Deck | 14 |
| PRE-OPERATING CHECKLIST | 14 |

SECTION 4 *Operating Instructions*

| | |
|------------------------------------------------------|----|
| CONTROL IDENTIFICATION | 16 |
| STARTING ENGINE | 17 |
| ADJUSTING GROUND SPEED AND STEERING | 17 |
| ENGAGING MOWER | 19 |
| STOPPING | 19 |
| ADJUSTING CUTTING HEIGHT | 20 |
| TRANSMISSION UNLOCK | 20 |
| RECOMMENDATIONS FOR MOWING | 20 |
| GHS OPERATION | |
| General Information | 20 |
| Clogging Checklist | 21 |
| Using 3.2 Bushel Catcher | 22 |
| Using 6.7 Bushel Catcher | 23 |

SECTION 5 *Maintenance*

| | |
|--------------------------------------------------|----|
| MAINTENANCE CHART | 25 |
| LUBRICATION | |
| Engine Break-In Oil | 26 |
| Check Engine Crankcase Oil Level | 26 |
| Change Engine Crankcase Oil | 26 |
| Lubricate Grease Fittings & Oil Points | 26 |
| Gearbox Lubrication | 27 |
| Lubricate Drive Chain | 27 |
| Check Hydrostatic Transmission Fluid Level | 27 |
| Change Hydrostatic Transmission Fluid | 28 |
| CLEANING | |
| Clean Engine Air Cooling System | 29 |
| Clean/Replace Carburetor Air Filter | 29 |
| Clean Mower Housing | 29 |
| GHS Blower | 30 |
| CHECKING/SERVICING | |
| Check Battery Electrolyte Level | 30 |
| Service Battery | 30 |
| Check Tire Pressure | 31 |
| Check/Sharpen Mower Blades | 31 |
| Check Drive Belts | 32 |
| Check Blade Drive Gearbox Oil Seal | 32 |
| Check Drive Chain Tension | 32 |
| Check/Replace Spark Plug | 32 |
| Check Breaker Points | 32 |
| Check Blade Brake Action | 32 |
| REPLACEMENT/REPAIR INSTRUCTIONS | |
| Replacing Drive Belts | 33 |
| Replacing Blade Shear Bolts | 33 |
| Replacing Fuel Filter | 33 |
| Replacing Mower Blade | 34 |
| Replacing Electric Clutch | 34 |
| Replacing Deck Gearboxes | 35 |
| Replacing GHS Blower Assembly | 36 |
| Replacing Compound Sprocket | 37 |
| ADJUSTMENT | |
| Final Drive Chain Tension | 38 |
| Transmission Control Adjustment | 38 |
| Forward Speed Control Lock | 40 |
| Electric Clutch | 40 |
| Carburetor | 41 |
| GHS Full Signal Adjustment | 42 |
| ◆ 3.2 Bushel (Air Pressure) | |
| ◆ 6.7 Bushel (Grass Pak Switch) | |
| Blade Brake Action | 43 |

SECTION 1

General Information

HIGHLIGHTED INFORMATION

Information of special importance has been highlighted in this manual. **DANGER, WARNING** and **CAUTION** identify personal safety related information and are further identified by the safety alert symbol . **IMPORTANT** identifies mechanical information demanding special attention since it deals with the possibility of damaging a part or parts of the machine. **NOTE** identifies information worthy of special attention.

IDENTIFYING NUMBER LOCATION

Tractor serial number is stamped on RH chassis bar, top edge, adjacent to fuel tank as shown by Photo 1-1. The mower deck serial number is stamped on the angle iron framing on the RH end of the RH blade drive gearbox as shown by Photo 1-2. The tractor model number is either MS36-42 when equipped with an 11-HP engine or MC36-54 with a 16-HP engine. The model and serial number will be helpful for obtaining replacement parts or maintenance assistance. For ready reference, please record these numbers in the space provided.

For the 11-HP Briggs & Stratton engine, the engine model, type and code number is stamped on top of the engine shroud. The 16-HP Kohler has a serial number decal on the lower portion of the engine shroud (below throttle control connection).

SERVICING OF ENGINE AND DRIVETRAIN COMPONENTS

The detail servicing and repair of engine, hydrostatic transmission and gearboxes are not covered in this manual; only routine maintenance and general service instructions are provided. For service of these components during the limited warranty period, it is important to find a local authorized servicing agent of the component manufacturer. Any unauthorized work done on these components during the warranty period may void your warranty. If you have any difficulty in finding an authorized outlet or in obtaining warranty service, please contact our Service Department for assistance.

Service manuals are available for each of these components from their respective manufacturers as follows:

| | |
|-----------------------------|------------------------------------------------------------------|
| B & S Engine | Briggs & Stratton Corp. Milwaukee, WI 53201 |
| Kohler Engine | Kohler Company Kohler, WI 53044 |
| Hydrostatic Transmission(s) | Eaton Corporation 15151 - Highway 5 Eden Prairie, MN 55344 |
| Gearbox(es) | Tecumseh Products Co. 900 North Street Grafton, WI 53024 |

Tractor Model No. _____

Tractor Serial No. _____

Deck Serial No. _____

Engine Model No. _____

Date of Purchase _____

Fill In By Purchaser

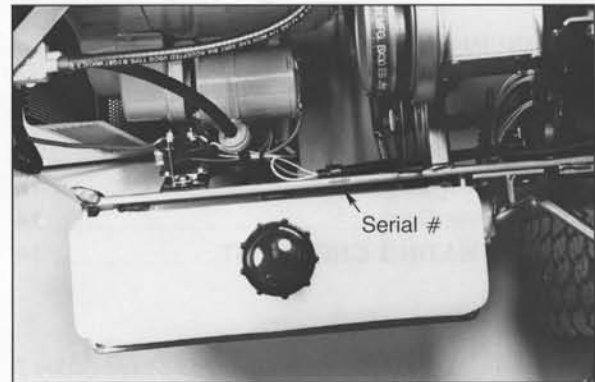

PHOTO 1-1 Tractor Serial No. Location

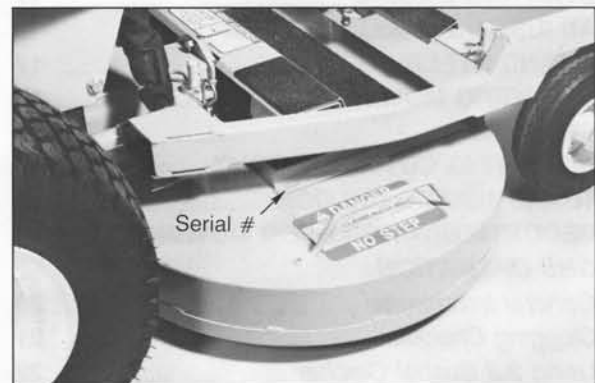

PHOTO 1-2 Deck Serial No. Location

SPECIFICATIONS

STANDARD 11-HP MODEL

Tractor Model MS36-42

ENGINE SPECIFICATIONS

Manufacturer/Model Briggs & Stratton Model
#254427 (I/C Series)
Displacement 24.36 Cu. In. (400cc)
HP 11 @ 3600 RPM
Max. RPM (No Load) 3650
Max. Torque (ft-lbs) 16.8 @ 2800 RPM
Idle RPM 1200 ± 150
Spark Plug Type Champion CJ-8 or Autolite 235
Spark Plug Gap .030"
Crankcase Capacity 3 Pints (1.42 Liters)
Crankcase Lubricant Detergent Oil Rated "SF" with
10W-30 Viscosity or 30W above
40° F only
Fuel Tank Capacity 3.0 U.S. Gallons (11.4 Liters)
Fuel Regular Grade Unleaded
Gasoline (87 Octane)

ELECTRICAL SYSTEM

Battery 12 Volt (Exide GT-9LM)
Charging System Flywheel Alternator
Charging Output 10 Amp DC (Regulated)
System Polarity Negative Ground
Ignition Electronic Magneto (B & S
Magnetron)
Starter 12 Volt Electric Ring-Gear
Type, Key and Solenoid
Operated
Interlock Switch Ignition Lockout by Seat
Switch, Transmission Neutral
and Blade Clutch

TRANSMISSION

Dual Eaton Hydrostatic
Model 7, Each Wheel
Independently Driven
Steering Hand Lever Control/Individual
Wheel
Forward Speed Control Precision Friction Lock Lever
Control with Neutral-Park
Position
Brake Hydraulic (Transmission Lock)
Neutral Transmission Release by
Manual Dump Valve
Final Drive #40 Roller Chain
Ground Travel Speed
Forward MPH 0-5 Infinitely Variable
Reverse MPH 0-5 Infinitely Variable

COMMERCIAL 16-HP MODEL

Tractor Model MC36-54

ENGINE SPECIFICATIONS

Manufacturer/Model Kohler Model #M16AQS
Specification No. 711536
Displacement 35.9 Cu. In. (588.2cc)
HP 16 @ 3600 RPM
Max. RPM (No Load) 3600
Max. Torque (ft-lbs.) 28.3 @ 2600 RPM
Governed RPM 3200
Idle RPM 1200 ± 75 RPM
Spark Plug Type Champion RH-10
Spark Plug Gap .025"
Crankcase Capacity 1¾ Quarts (1.66 Liters)
Crankcase Lubricant Detergent Oil Rated "SF" with
30W Straight Viscosity (Use
Multi-Viscosity only Below
32° F, 10W-40)
Fuel tank Capacity 3.0 U.S. Gallons (11.4 Liters)
Fuel Regular Grade Unleaded
Gasoline (87 Octane)

ELECTRICAL SYSTEM

Same As Standard Model Except:
Charging Output 15 Amp DC (Regulated)

TRANSMISSION

Same As Standard Model

SPECIFICATIONS

STANDARD MODEL (Continued)

Transmission Fluid
Factory Service _____ Type SE 10W, 20W or 30W
Straight Viscosity Motor Oil
(20W Installed from Factory)

Alternate
Replacement _____ Mobil 1 Synthetic Motor Oil
(5W-30)

Transmission Fluid
Capacity _____ 1 U.S. Quart
Transmission
Cooling _____ Cooling Fan Integral to
Drive Pulley

BLADE DRIVE

PTO Shaft _____ Quick Disconnect Rectangular
Shaft with Two High-Speed
U-Joints

Blade Spindle _____ Each Blade (2) Mounts Direct
on Peerless Right Angle
Gearbox with "TEE" Gearbox in
Center Connected to PTO Shaft
(Complete Geared Drive, Peer-
less Model 1000 Gearboxes)

Blade Drive Clutch
and Brake _____ Manual Belt Tension Clutch
and Scrubber Brake (Stops
Blades within 5 Seconds of
Disengagement)

Max. Blade Speed
@ 3600 RPM Engine _____ 2900 RPM (16700 FPM with
22" Blade)

TIRE SIZE

Deck Caster Wheel _____ 8.25 x 2.75 Semi-Pneumatic
Deck Caster Wheel
(Optional) _____ 2.80/2.50-4 Pneumatic (4 Ply)
Drive _____ 18 x 6.50-8 (2 Ply)
Drive
(Optional Wide Tire) _____ 18 x 8.50-8 (4 Ply)
Rear _____ 13 x 6.50-6 (2 Ply)

TIRE PRESSURE

Deck Caster Wheel
(Opt. Pneumatic) _____ 20 PSI
Drive _____ 15 PSI
Rear _____ 20 PSI

COMMERCIAL MODEL (Continued)

BLADE DRIVE

Same As Standard Model Except:

Blade Drive Clutch
and Brake _____ 12V Electrical (Electromagnetic
Clutch and Brake) Switch
Operated, Brake Stops Blades
within 5 Seconds of
Disengagement

Max. Blade Speed
@ 3200 RPM Engine _____ 2900 RPM (16700 FPM with
22" Blade)

TIRE SIZE

Same As Standard Model

TIRE PRESSURE

Same As Standard Model

SPECIFICATIONS

STANDARD MODEL (Continued)

DIMENSIONS (TRACTOR AND MOWER)

Length

36" Mower _____ 87"

42" Mower _____ 89"

Width

36" SD Mower _____ 41 $\frac{3}{4}$ "

(w/Grass Deflector)

42" SD Mower _____ 47 $\frac{3}{4}$ "

(w/Grass Deflector)

36" GHS Mower _____ 37"

42" GHS Mower _____ 43"

Height _____ 37 $\frac{1}{2}$ " (Add 7" Height if
6.7 GHS Installed)

Wheel Base

(Tractor) _____ 42 $\frac{1}{4}$ "

Tread Width

(Tractor) _____ 28" (Standard Tires)

CURB WEIGHT (APPROXIMATE)

Tractor Only _____ 465 lbs.

36" SD Mower
and Tractor _____ 625 lbs. (Incl. Utility Bed)

42" SD Mower
and Tractor _____ 650 lbs. (Incl. Utility Bed)

36" GHS 3.2
Mower/Tractor _____ 680 lbs.

36" GHS 6.7
Mower/Tractor _____ 700 lbs.

42" GHS 6.7
Mower/Tractor _____ 720 lbs.

MOWER DECK

Width of Cut

36" SD/GHS _____ 36"

42" SD/GHS _____ 42"

Cutting height _____ 1" to 4"

Height Adjustment _____ 7 Positions - $\frac{1}{2}$ " Increment
Hitch Pins Installed in
Multi-Position Deck Support

Blade Size

36" SD _____ 20" (4" Center Overlap)
(Two Blades, CW Rotation)

36" GHS _____ 20" (4" Center Overlap)
(Two Blades, Counter Rotate)

42" SD _____ 22" (2" Center Overlap)
(Two Blades, CW Rotation)

42" GHS _____ 22" (2" Center Overlap)
(Two Blades, Counter Rotate)

Deck Suspension _____ Torsion-Flex Frame with
Caster Wheels and Counter-
weight Springs

COMMERCIAL MODEL (Continued)

DIMENSIONS (TRACTOR AND MOWER)

Same As Standard Model Except:

Length

54" Mower _____ 87"

Width

54" SD Mower _____ 59 $\frac{3}{4}$ "

(w/Grass Deflector)

CURB WEIGHT (APPROXIMATE)

Tractor Only _____ 540 lbs.

42" SD Mower
and Tractor _____ 725 lbs.

54" SD Mower
and Tractor _____ 775 lbs.

36" GHS 6.7
Mower/Tractor _____ 775 lbs.

42" GHS 6.7
Mower/Tractor _____ 795 lbs.

MOWER DECK

Same As Standard Model Except:

Width of Cut

54" SD _____ 54"

Blade Size

54" SD _____ 20" (3" Center Overlap)
(Three Blades, CW Rotation)

SPECIFICATIONS

STANDARD MODEL (Continued)

GHS SYSTEM (OPTIONAL)

| | |
|------------------------|---------------------------------------------------------------------------------------------------------------------------------|
| Blower | 3½ x 9 x ¼" Three Blade Paddle Wheel (Driven by Mower Engine) |
| Blower Brake | Belt Scrubber Brake (Works in Combination with PTO Clutch, Stops Blower within 5 Seconds of PTO Disengagement) |
| Max. Blower Speed | 3600 RPM |
| Grass Catcher Capacity | 30 Gal./3.2 Bushel or 63 Gal./6.7 Bushel |
| Full Signal | |
| GHS 3.2 | Pressure Switch Operates Horn Circuit @ 1.25" Water Gage Pressure (Back Pressure) |
| GHS 6.7 | Oscillating Vane Switch Mounted on Grass Delivery Spout Triggers Horn Signal |
| Powerfil | |
| GHS 6.7 (Only) | Oscillating Delivery Spout Driven by 12V Electric Gear-motor Spreads Material Throughout Interior of Catcher @ 25 Cycles/Minute |
| SEAT | Contour-Molded, with Nylon Backed Vinyl Cover and Integral Foam Cushion |

FRAME/BODY CONSTRUCTION

| | |
|------------------------|--------------------------------------------------|
| Frame | All Welded Unitized Steel Chassis |
| Body | 14 ga. Steel |
| Deck | 11 ga. Steel |
| GHS Catcher and Chutes | Molded Cross-Linked Polyethylene (UV Stabilized) |

DRIVE BELTS

| | |
|-----------------------------|---------------------|
| Engine Belt | Gates #6932 or B30 |
| Ground Drive | Gates #6847 or AX45 |
| PTO Drive (SD Mower) | Gates #6935 or B32 |
| GHS Drive (Blades & Blower) | Gates #6944 or B41 |

NOTE: The manufacturer reserves the right to make changes in specifications shown herein at any time without notice or obligation.

COMMERCIAL MODEL (Continued)

GHS SYSTEM (OPTIONAL)

| | |
|--------------------------------|---------------------------------------------------------------------------------------------------|
| Same As Standard Model Except: | |
| GHS 3.2 | Not Available |
| Blower Brake | Works in Combination with PTO Electric Brake (Stops Blower within 5 Seconds of PTO Disengagement) |

| | |
|------|------------------------|
| SEAT | Same As Standard Model |
|------|------------------------|

FRAME/BODY CONSTRUCTION

Same As Standard Model

DRIVE BELTS

| | |
|-------------------------------------------|---------------|
| Engine Belt (Two Required) | Gates #3VX425 |
| Ground Drive | Gates #6845 |
| PTO Drive (SD Mower, Two Required) | Gates #3VX355 |
| GHS Drive (Blades & Blower, Two Required) | Gates #3VX425 |

SECTION 2

Safety Instructions

 This safety alert symbol means **CAUTION, WARNING** or **DANGER** concerning personal safety. When you see this symbol read, understand and follow the instructions because it is important for safety. Failure to comply with the instructions may result in personal injury.

The Walker Rider Lawnmower has been designed with many safety features to protect the operator from personal harm or injury. However, it is necessary for the operator to use safe operating practices at all times. **Failure to follow the safety instructions contained in this manual may result in personal injury or damage to equipment or property.**

If you have any questions concerning set-up, operation, maintenance or safety, please contact your authorized Walker Mower Dealer or call Walker Manufacturing Company at (303) 226-1514.

BEFORE OPERATING

A. Read and understand the contents of this Owner's Manual before starting and operating the machine. Become thoroughly familiar with all controls and how to stop the machine and disengage the controls quickly. A replacement Owner's Manual is available by sending Model and Serial No. to:

Walker Manufacturing Company
5925 East Harmony Road
Fort Collins, CO 80525

B. Never allow children to operate rider mower. Do not allow adults to operate without proper instruction.

C. Clear area to be mowed of foreign objects which may be picked up and thrown by cutter blades. Pick up all sticks, stones, wire and any other debris.

D. Keep everyone, especially children and pets, a safe distance away from area being mowed. Do not mow with bystanders in area.

E. Do not operate machine barefoot or wearing sandals, sneakers, tennis shoes or similar lightweight footwear. Wear substantial protective footwear.

F. Do not wear loose fitting clothing that could get caught in moving parts. Do not operate machine wearing shorts; always wear adequate protective clothing including long pants. Wearing safety glasses, safety shoes and helmet is advisable and required by some local ordinances and insurance regulations.

G. Prolonged exposure to loud noise can cause impairment or loss of hearing. **Operator hearing protection is recommended;** particularly for continuous operation of GHS Model due to blower noise level. Wear a suitable hearing protective device, such as earmuffs or earplugs.

H. Keep all shields and safety devices in place. If a shield, safety device or decal is defective or damaged, repair or replace it **before** operating machine.

I. Be sure interlock switches are functioning correctly so engine cannot be started unless Forward Speed Control is in "**Neutral**" position and PTO clutch is in "**Disengage**" position. Also engine should stop if the operator lifts off the seat with the PTO clutch in the "**Engage**" position.

J. Handle gasoline with care; it is highly flammable and its vapors are explosive:

- Use an approved fuel container.
- Never add fuel to a running engine or hot engine (allow hot engine to cool several minutes).
- Keep matches, cigarettes, cigars, pipes, open flames or sparks away from fuel tank and fuel container.
- Fill fuel tank outdoors with extreme care – up to about one inch from top of tank. Never fill fuel tank indoors. Use funnel or spout to prevent spilling.
- Replace machine fuel cap and container cap securely and clean up spilled fuel before starting engine.

K. Never attempt to make any adjustments while the engine is running, except where specifically instructed to do so.

L. Battery for electric system contains sulfuric acid. Avoid contact with skin, eyes and clothing. Keep battery and acid out of reach of children.

OPERATING

- A.** Operate mower only in daylight or in good artificial light with visibility of area being mowed.
- B.** Sit on the seat when starting the engine and operating the machine. Keep feet on deck footrests at all times when the tractor is moving and/or the mower blades are operating.
- C.** For beginning operator, learn to steer (maneuver) tractor with slow engine speed before attempting mowing operation. Be aware that with the front mounted mower configuration the back of the tractor swings to the outside during turns.
- D.** Remember – motion of the tractor can always be stopped by pulling the Forward Speed Control into “**Neutral-Park**” position.
- E.** Disengage blade clutch (switch on commercial model) and put Forward Speed Control in “**Neutral**” position before starting engine (an ignition interlock switch normally prevents starting if these controls are in “Operating” position).
- F.** Do not run engine in a confined area without adequate ventilation. Exhaust fumes are hazardous and could be deadly.
- G.** Do not carry passengers – maximum seating capacity is one person.
- H.** Watch for holes, rocks and roots in the terrain and other hidden hazards. When mowing tall grass, mow higher than desired to expose any hidden obstacles and then clean area and mow to desired height.
- I.** Avoid sudden starts or stops. Before backing up, look to rear to be sure no one is behind the machine.
- J.** Disengage blade drive when transporting across drives, sidewalks, etc. Never raise the mower deck while blades are rotating.
- K. Maximum recommended side slope operating angle is 20 degrees or 33% grade.** When operating on a slope, reduce speed and use caution to start, stop and maneuver. Avoid sharp turns or sudden changes in direction on a slope to prevent tipping or loss of control.

L. Before adjusting cutting height or servicing, disengage blade drive, stop engine and remove ignition key. Wait for all movement to stop before getting off the seat. (Note: A blade/blower brake should normally stop rotating drive line within 5 seconds of disengaging PTO clutch.)

M. For side discharge mower decks, do not operate with grass deflector chute removed and keep the deflector in the lowest possible position.

N. For GHS Models, do not operate with grass catcher in “Dump” position or with the back door “Open” – dangerous projectiles may be thrown.

O. In case of clogging or plugging of mower deck or GHS catching system:

- Disengage PTO clutch and shut engine off before leaving seat.
- Before unclogging, look at blade drive shaft and blower drive pulley to make sure all movement has stopped.
- Disconnect spark plug wire.
- Never place hand under deck or in GHS blower – use stick or similar instrument to remove clogged material.

P. If the cutting blades strike a solid object or the machine begins to vibrate abnormally, immediately disengage PTO clutch, stop the engine, wait for all moving parts to stop and disconnect the spark plug wire to prevent accidental starting. Then, thoroughly inspect the mower for any damage and repair the damage before restarting the engine and operating the mower. Make sure cutter blades are in good condition and blade nuts are tight.

Q. Do not touch engine or muffler while engine is running or immediately after stopping since these areas may be hot enough to cause a burn.

MAINTENANCE

A. Remove key from ignition switch and disconnect spark plug wire to prevent accidental starting of engine when servicing or adjusting machine.

B. To reduce fire hazard, keep the engine free of grass, leaves, excessive grease and dirt.

C. Keep all nuts, bolts and screws tight to be sure machine is in safe working condition. Check blade mounting nuts frequently to be sure they are tight.

D. Perform only the maintenance instructions described in this manual. Unauthorized maintenance operations or modifications to the equipment may result in unsafe operating conditions.

E. If the engine must be running to perform a maintenance adjustment, keep hands, feet and clothing away from moving parts.

F. Never attempt to disconnect any safety devices or defeat the purpose of these safety devices.

G. Do not change the engine governor settings or overspeed the engine. Maximum engine RPM is 3650 for MS Model and 3200 for MC Model.



PHOTO 2-1

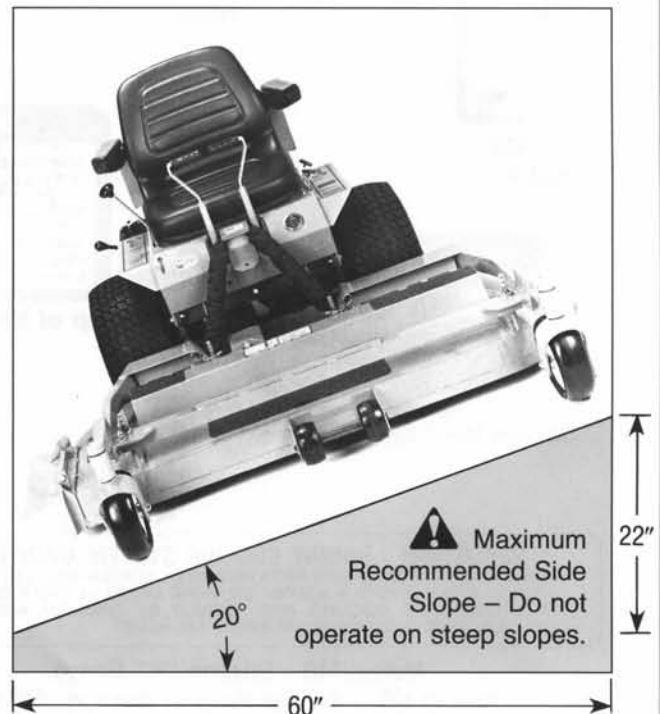

PHOTO 2-2

1. For emergency stop pull Forward Speed Control into "Neutral-Park"

2. Keep feet on footrest at all times machine or cutter blades are moving

PHOTO 2-3





SAFETY AND INSTRUCTION DECALS

Safety and Instruction Decals are installed on the Machine;
If any are missing, illegible or damaged, a replacement should be ordered and installed.
The Decal Part Number is listed below and in the Parts Catalog.

MODEL M36-42
DESIGNED AND BUILT BY
WALKER MFG COMPANY
FORT COLLINS, CO 80525

PATENT NO. 2,180,240
OTHER PATENTS PENDING

FAST
THROTTLE
IDLE

WARNING
READ AND UNDERSTAND
OWNER'S MANUAL BEFORE
OPERATING THIS MACHINE.
KEEP ALL GUARDS IN PLACE.
OPERATOR HEARING
PROTECTION IS RECOMMENDED
FOR CONTINUOUS OPERATION OF
THIS MODEL.
NOT EQUIPPED WITH AUXILIARY
PARKING BRAKE. CHECK WHEELS
IF PARKED ON SLOPE.

ON
CHOKE
OFF

LH Fender
(5802-2)

DANGER

- DO NOT REMOVE THIS DISCHARGE SHIELD
- KEEP SHIELD IN THE LOWEST POSSIBLE POSITION

THROWN OBJECTS

SD Deck Discharge Shield (5848)

DANGER

ROTATING BLOWER BLADES

- DO NOT PUT HANDS INTO DISCHARGE CHUTE -- BLADES MAY CONTINUE TO SPIN AFTER DISENGAGING CLUTCH
- DO NOT OPERATE MOWER WITH GRASS CATCHER IN DUMP POSITION -- OBJECTS MAY BE THROWN FROM DISCHARGE CHUTE.

DISCHARGE CHUTE

Adjacent to Blower Discharge Chute Through Body (5804)

TO START
TRANSMISSION MUST BE
IN NEUTRAL AND BLADE
CLUTCH DISENGAGED

**FORWARD
SPEED
CONTROL**

FAST
↓
SLOW

NEUTRAL-PARK

1 TO GO
ADJUST LEVER
FORWARD TO
DESIRED GROUND
SPEED

2 TO STOP
PULL STEERING
LEVERS TO NEUTRAL
BEFORE MOVING
SPEED CONTROL
TO NEUTRAL

RH Fender
(5802-1)

BLADE CLUTCH

WARNING
DO NOT ENGAGE CLUTCH WITH
PTO SHAFT DISCONNECTED

PULL OUT
AND UP
TO ENGAGE

ON
OFF

Model MC Clutch Control
(6806)

DANGER

ROTATING CUTTING BLADES

- DO NOT PUT HANDS OR FEET UNDER OR INTO ANY PART OF THIS MOWER DECK OR DISCHARGE CHUTE
- OBJECTS MAY BE THROWN FROM MOWER
 - CLEAR LAWN OF DEBRIS AND OBJECTS
 - DO NOT MOW WITH BYSTANDERS IN AREA

NO STEP

Each End Of Mower Deck (5808)

IMPORTANT

WHEN GRASS IS DIRTY AND DAMP (ESPECIALLY SPRINGTIME), INSIDE BLOWER HOUSING MAY ACCUMULATE A DEPOSIT OF DIRT CAUSING WEAR AND BINDING OF BLOWER WHEEL UNDER THESE CONDITIONS, CHECK BLOWER WHEEL FREQUENTLY FOR BINDING AND USE PRESSURE WASHER TO CLEAN DEPOSITS-- BLOWER WHEEL MUST SPIN FREELY

Top of Blower Housing (5819)

BLADE CLUTCH

WARNING
DO NOT ENGAGE CLUTCH
WITH PTO SHAFT
DISCONNECTED

Model MS Clutch Control (5806)

CAUTION

HOT EXHAUST

Engine Exhaust
On Side of Body
(5805)

IMPORTANT - ENGINE COOLING SYSTEM MAINTENANCE
CHECK AND CLEAN ENGINE ROTATING INLET SCREEN AND STATIC SCREEN GUARD DAILY (EVERY 8 HOURS) OR MORE OFTEN IN DIRTY CONDITIONS. CYLINDER HEAD COOLING FINS SHOULD BE CHECKED AND CLEANED BY REMOVING ENGINE SHROUD EVERY 100 HOURS.

Model MS - Engine "V" Brace
Model MC - Top of Engine Shroud (5855)

CUTTING HEIGHT ADJUSTMENT

CAUTION
STOP ENGINE
BEFORE ADJUSTING
CUTTING HEIGHT

DECK SUPPORT PIN

CUTTING HEIGHT INCHES
TOP HOLE 1
1-1/2 2
2-1/2 3
3-1/2 4
BOTTOM HOLE

Deck Gearbox Cover (5807)

SECTION 3

Assembly Instructions

SET-UP INSTRUCTIONS

The Walker Mower is shipped partially assembled. After uncrating the tractor and mower deck, five (5) items of initial set-up will need to be completed.

NOTE: During process of unpacking, any damaged or missing parts should be noted and reported to the delivering carrier immediately (put in writing within 15 days). The carrier will advise you how to proceed with your claim to receive compensation for the damage.

STEP 1 *Install Tires (Tractor)*

- Install drive tires (eight (8) lug nuts are located in the owner's packet of materials). If optional wide tires 18x8.50-8 are being installed, the spacer hub is bolted onto the tractor hub first and then the tire assembly.
- Check and adjust tire inflation:
 - Drive Tire = 15 PSI
 - Rear Tire = 20 PSI

STEP 2 *Service Battery*

Tilt mower body up (lift on rear of body) and check battery for electrolyte level and charge. Electrolyte level should be at bottom of vent wells (¼ to ½ inch above plates). If specific gravity is less than 1.225, the battery will need to be charged. See paragraph (A) instructions if battery has been shipped dry or paragraph (B) on page 12 if battery needs service.

A. To fill (activate) battery with electrolyte (if battery has been shipped dry):

DANGER

Activating a battery is dangerous work. We recommend taking the battery to a reliable service station, battery store or power equipment dealer where a trained technician can activate the battery safely. Do not attempt to activate the battery unless you are experienced in battery service work. The following activation and charging instructions are provided for use by a trained battery technician.

DANGER

- Battery electrolyte is a poisonous and corrosive sulfuric acid solution.
- Avoid spillage and contact with skin, eyes and clothing – causes severe burns.
- To prevent accidents, wear safety goggles and rubber gloves when working with electrolyte.
- Neutralize acid spills with baking soda and water solution.

- Remove battery hold down bar, disconnect battery cables and lift battery out of battery tray.

IMPORTANT: Battery must be removed from mower before filling with electrolyte.

- Obtain and use only battery grade sulfuric acid electrolyte with 1.265 specific gravity to activate battery. Do not use water or any other liquid during initial activation.
- Remove filler caps and carefully fill each cell until electrolyte is just above the plates.
- Charge battery at 15 amps for 10 minutes. **Do not** exceed 20 amps maximum recommended charging rate. Charge until specific gravity is at least 1.250. Total charging time should not exceed one (1) hour.

DANGER

Batteries Produce Explosive Gases

- Charge battery in a well ventilated space so gases produced while charging can dissipate.
- Keep sparks, flame, smoking materials away from battery at all times.
- Make sure manifold vent of battery is open after battery is filled with acid (check manifold vent on negative terminal end of battery).

- After charging, adjust electrolyte level to bottom of vent wells (¼ to ½ inch above plates).

IMPORTANT: Do not overfill battery. Electrolyte will overflow through vent tube onto parts of machine resulting in severe corrosion.

- Reinstall battery in mower as shown by Photo 3-1 for Model MS or Photo 3-2 for Model MC. Connect positive and negative cables to proper battery terminal (red cable and boot connects to Positive (+) terminal). Slide the rubber boot up and over the battery post, making sure it covers the post completely to prevent electric short-out.

- Route and secure the battery vent tube as shown by Photo 3-1 or 3-2 from manifold vent on Negative (-) terminal end of battery and check tube free of restriction. **Use plastic wire tie to secure vent tube to frame.**

CAUTION

Make sure the battery vent tube is not crimped, folded or pinched anywhere along its length. Improper venting could cause a battery explosion.

B. If battery has been shipped wet, but electrolyte level is low or battery needs to be charged then:

- Fill each battery cell with **drinking water** to bottom of vent wells.
- Charge battery per item (4) paragraph (A).

STEP 3 Assemble Mower Deck

A. Install Deck Caster Wheels

- Remove bolt, nut, axle spacer tube and spacer washers from each deck caster wheel fork.

NOTE: Spacer washers are not used when the optional pneumatic deck wheels (2.80/2.50-4) are installed.

- Fit axle spacer tube through wheel hub, position spacer washer on each side of hub (if used) and fit this assembly into fork. Insert ¾-16 x 4½ bolt through fork with bolt head to outside and install ¾-16 KEPS nut. See Photo 3-3.

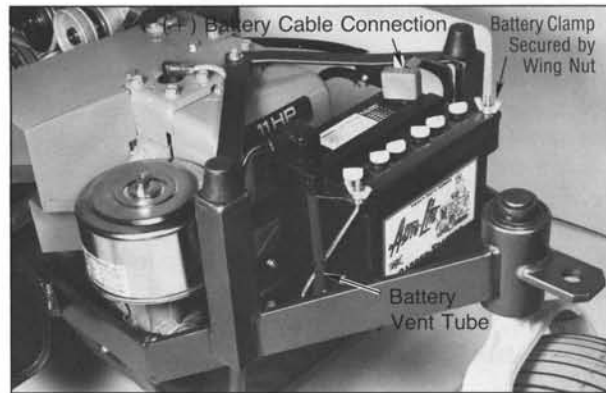

PHOTO 3-1 Battery Installation in Model MS

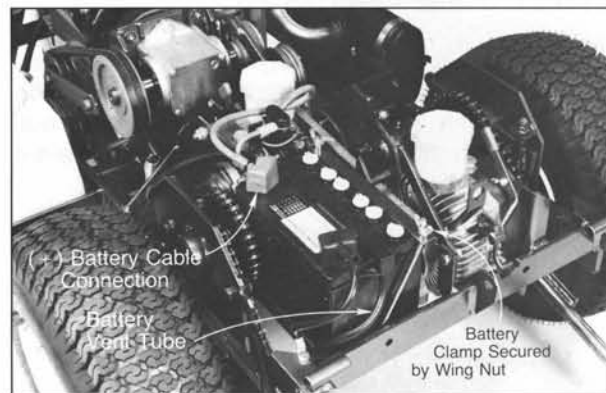

PHOTO 3-2 Battery Installation in Model MC

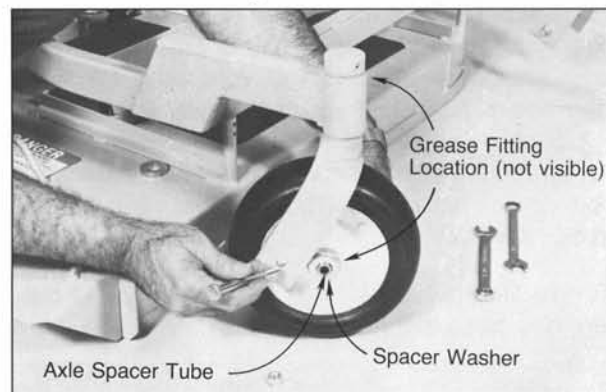

PHOTO 3-3 Installing Deck Caster Wheel

- Tighten bolt and nut until axle spacer tube bottoms against inside of wheel fork (will not turn) while the wheel and spacer washers spin free with no binding.

NOTE: Make sure spacer washers are fitting over the spacer tube and not caught between fork and end of tube. Washer should move freely on tube.

- Grease caster wheel bearings and caster pivot bearings (one grease fitting each wheel and each pivot). See Photo 3-3.

B. Install Deck Discharge Chute
(GHS Rear Discharge Models Only)

Mount discharge chute hinge on top of deck discharge opening using $\frac{1}{4}$ -20 x $\frac{1}{2}$ socket button head bolt and $\frac{1}{4}$ -20 ESNA nut. Orient bolt with head inside of chute and nut on the outside. See Photo 3-4.

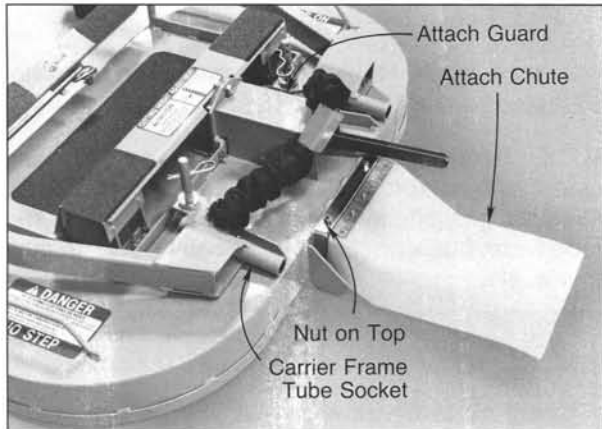

PHOTO 3-4 *Assembly of Discharge Chute & PTO Shaft Guard on Rear Discharge Deck*

C. Install Deck Discharge Shield
(Side Discharge Models Only)

Attach deck side discharge shield by positioning shield hinge lug in **front** of deck mount and fastening with two $\frac{3}{8}$ -16 x $1\frac{1}{4}$ bolts, $\frac{3}{8}$ -16 ESNA nuts and $\frac{3}{8}$ wavey spring washers as shown by Photo 3-5. The wavey washer fits between the two hinging surfaces. Tighten nuts until shield moves easily but is not loose.

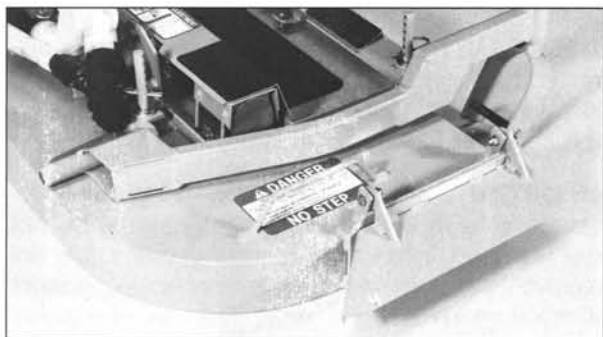

PHOTO 3-5 *Assembly of Discharge Shield on Side Discharge Deck*

D. Install PTO Shaft Guard

Position shaft guard as shown by Photo 3-4 and mount with two $\frac{1}{4}$ -20 x $\frac{1}{2}$ bolts.

STEP 4 Install Mower Deck

A. Lightly grease deck support arm shaft on tractor. See Photo 3-6.

B. Engage deck carrier frame tube sockets on tractor support arms and slide approximately 3". See Photo 3-4, for socket location.

C. Align and connect the rectangular PTO shaft and socket halves and slide deck completely on support arm. The PTO shaft has a pilot end to ease alignment of shaft – fit shaft end into socket and rotate shaft until rectangles line up, then slide together. See Photo 3-6.

D. If the deck is rear discharge (GHS Model), the rear discharge chute will need to be aligned and connected to blower inlet during last 2" of slide action on support arms.

NOTE: Raising mower body may be helpful in fitting and guiding deck chute into blower.

E. Install hitch pin through hole on end of each support arm to lock deck in place (two (2) Part No. 5775-2 hitch pins are included in owner's packet of materials). See Photo 3-7.



PHOTO 3-6 *Mower Deck Installation (PTO Shaft Connection)*

F. Raise mower body (instead of lifting front of deck) and clip counterweight springs to receptacle on front of body as shown by Photo 3-7. Lower body to tension springs.

G. With counterweight springs connected, weight on deck caster wheels should be 15-25 lbs. Check this weight by lifting on front of deck carrier frame, and if required, the spring tension can be increased or decreased by tightening or loosening elastic stop nuts located underneath lower spring hook. See Photo 3-7.



PHOTO 3-7 Deck Counterweight Spring Installation

STEP 5 Level Mower Deck

A. Position mower on smooth – level surface. Set cutting height (See page 20 Instructions) to highest position (4") for easy access under deck to measure blade height.

NOTE: A block of wood cut 4" high is a convenient gauge to measure blade height above ground during checking process.

B. Check side-to-side level – rotate each blade sideways and measure distance from blade tip to ground on each side. If measurements vary more than $\frac{1}{8}$ ", add washer shim under deck support pins on low side to level.

C. Check front-to-rear level – rotate blades to point forward and measure distance from blade tip to ground on front and rear. **Rear of blade should be $\frac{1}{8}$ - $\frac{1}{4}$ " higher** than front; shim rear (or front) deck support pins equally to achieve at least $\frac{1}{8}$ " difference.

NOTE: The mower deck and support frame are jig welded and within normal tolerances very little, if any, shimming should be required to level deck. Tire inflation will influence the levelness of the deck; check tire inflation as possible cause of unlevelness.

PRE-OPERATING CHECKLIST

The following is a list of items to be checked before operating the mower initially and before routine daily operations. (For a mower with frequent operation, some of these items will not need to be checked every day, but the operator should be aware of the condition of each.)

FILL FUEL TANK

Use clean, fresh, regular grade **unleaded** gasoline (87 octane rating minimum).

NOTE: Regular grade **leaded** gasoline may be used if unleaded is not available. However, use of unleaded gasoline is recommended because of reduced combustion chamber deposits and longer engine life.

WARNING

Gasoline is flammable and vapors are explosive. Use safe refueling procedures:

- Do not fill tank with engine running.
- If engine is hot, allow to cool before refueling.
- Use an approved fuel container.
- Fuel mower outdoors.
- Do not smoke.
- Avoid spilling fuel; use funnel or spout.
- Do not overfill tank; fill up to about 1 inch below top of tank.

IMPORTANT: Do not permit dirt or other foreign matter to enter fuel tank. Wipe dirt from around filler cap before removing. Use clean gasoline storage can and funnel.

IMPORTANT: DO NOT MIX oil WITH gasoline. Always use fresh automotive grade gasoline. Do not use premium, white or high test gasoline. Do not use additives, such as carburetor cleaners, deicers or moisture removing agents. The use of gasohol (gasoline – alcohol blend) is not recommended.

CHECK CRANKCASE OIL LEVEL

Check the oil level in engine before use and after each 5 hours continuous operation:

- Mower should be parked on level surface with engine stopped.

IMPORTANT: Never attempt to check or add oil with engine running.

- Before removing dipstick, clean area around fill tube to keep dirt and debris out of engine.

- Remove fill cap/dipstick, wipe with clean rag, reinsert the dipstick and push it all the way down into tube. Remove the dipstick and check the level. Oil level should be within safe range (between "F" and "L" marks on Kohler engine or "Full" and "Add" marks on B & S engine).

- If additional oil is needed, refer to Engine Specifications (Section 1) for proper crankcase lubricant and **fill to full mark.**

IMPORTANT: Do not overfill (oil above full level) as this can result in engine overheating and possible engine damage.

CHECK AND SERVICE ENGINE AIR CLEANER

- Remove air cleaner cover and check air cleaner filter elements are in place and securely attached to engine.

- Check cleanliness of air filter elements (clean at least every 25 hours, see Section 5).

ADJUST CARBURETOR (Initial Start-Up Only)

The carburetor has been adjusted at the factory at 5000 ft. ASL. At most locations, the carburetor will need to be readjusted to compensate for altitude. Refer to Section 5 for carburetor adjustment procedure.

CHECK ENGINE COOLING SYSTEM

Check engine cooling air intake screen is free of obstruction by grass clippings or debris and clean if required. Also cylinder head cooling fins should be inspected and cleaned if any buildup of debris is noted (remove cylinder head shroud to clean).

INSPECT THREE DRIVE BELTS (Engine, PTO, Transmission Drive)

CHECK DRIVE CHAIN TENSION (Initial Adjustment at 25 Hours); See Section 5 for adjustment instructions.

CHECK HYDROSTATIC TRANSMISSION OIL LEVEL. See Section 5 for servicing transmission oil.

CHECK BATTERY ELECTROLYTE LEVEL. Refer to Section 5 for battery servicing.

CHECK TIRE PRESSURE

Drive Tire = 15 PSI

Rear Tire = 20 PSI

Deck Caster Wheel (Optional Pneumatic) = 20 PSI

CHECK AND CLEAN GRASS BUILDUP UNDERNEATH MOWER DECK (and inside GHS blower if so equipped, See Section 5 instructions for cleaning blower).

NOTE: Mower deck is secured in raised position for cleaning and changing blades by hooking the deck lift rod into the body bracket below the counterweight spring clip. The rod is hinged and is stowed along the footrest of the deck carrier frame. See Photo 3-8.

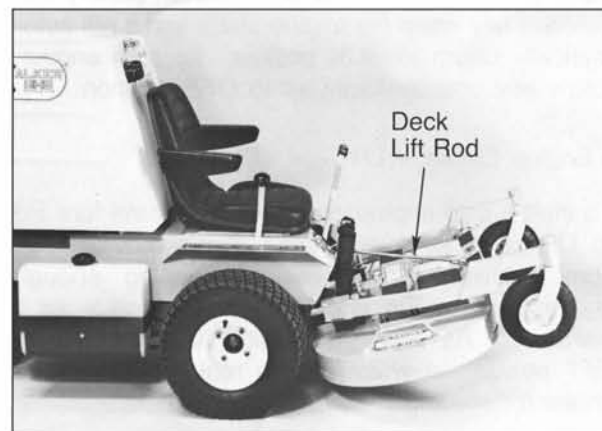

PHOTO 3-8 Deck Secured in "Up" Position

⚠ DANGER

Never Operate Cutter Blades with Deck in Raised Position because It Is Hazardous.

CHECK MOWER BLADE CONDITION, SHARPNESS AND SECURITY OF MOUNTING. Blade mounting nut should be tightened to 60 ft-lbs. See Section 5 instructions if blade sharpening required.

ADJUST MOWER CUTTING HEIGHT IF REQUIRED (position hitch pins in four deck support pins per "cutting height adjustment" decal on deck gearbox cover).

PERFORM ANY ADDITIONAL MAINTENANCE PROCEDURES CALLED OUT ON THE MAINTENANCE CHART, Section 5.

SECTION 4

Operating Instructions

CONTROL IDENTIFICATION AND FUNCTION

Before operating the mower, familiarize yourself with all mower and engine controls. Knowing the location, function and operation of these controls is important for safe and efficient operation of the mower. There are **seven** operator controls; Photos 4-1 and 4-2 identify control locations:

- Ignition Switch – RH Front of Body

The ignition switch is used to start and stop the engine and has three positions: OFF, RUN, START. Rotate key clockwise to START position. Do not hold key in START position longer than 15 seconds. If engine does not start, return the key to OFF position for at least 60 seconds before a restart attempt is made. Prolonged cranking can damage the starter motor and shorten battery life. Release key when the engine starts and it will automatically return to RUN position. To stop engine, rotate key counterclockwise to OFF position.

- Engine Choke – LH Side of Seat

To start a cold engine, move choke control forward to ON position. After engine starts, move choke control toward OFF position, keeping enough choke to allow the engine to run smoothly as it warms up. As soon as possible, move choke to OFF position. A warm engine requires little or no choke for starting.

IMPORTANT: Make sure choke is in OFF position during normal engine operations; running with choke ON can damage engine.

- Engine Throttle – LH Side of Seat

The throttle is used to control engine speed. Moving throttle forward increases engine speed – FAST; rearward decreases engine speed – IDLE.

- Steering Levers – Front/Center of Body

RH and LH steering levers independently control RH and LH drive wheels for both steering and forward/reverse. Levers operate only by a **PULLING** movement (Forward Speed Control sets forward position of levers) which causes the drive wheel to first slow down, stop and then reverse with a full rearward lever stroke. Levers are released to forward position for “straight-ahead” ground travel.

NOTE: Pushing forward on the steering levers will not cause any change in motion of the tractor – nothing happens and there will be no damage to the machine.

- Forward Speed Control – RH Side of Seat

Forward Speed Control has two functions: One is to set forward travel speed and the other is to establish the **NEUTRAL-PARK** position. The FSC lever is moved forward and by friction lock holds any forward speed setting from 0-5 mph. Ground speed is proportional to lever position; the further the lever is advanced forward, the faster the tractor moves. It is not necessary to hold the FSC in position since the friction lock maintains the selected lever position. Pulling back on the steering levers

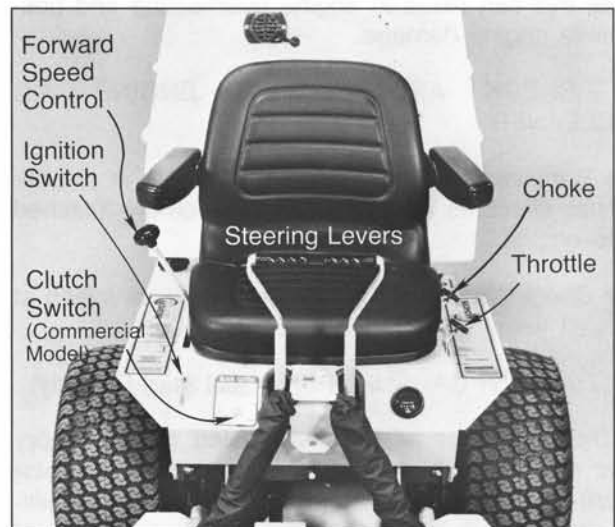

PHOTO 4-1 Location of Operator Controls

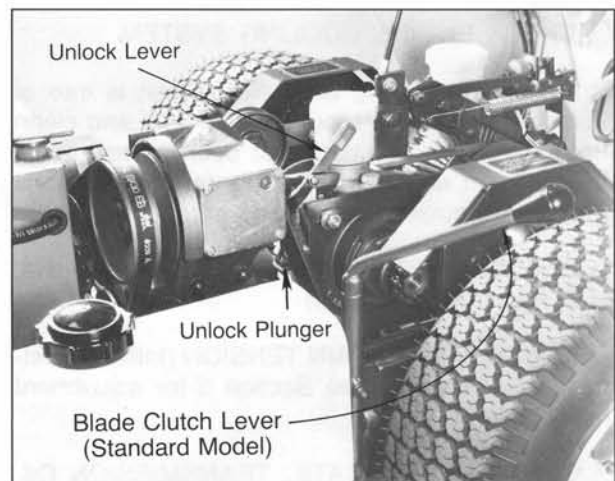

PHOTO 4-2 Location of Transmission Unlock (and Blade Clutch Lever on Standard Model)

overrides the FSC setting and slows or stops forward travel while releasing steering levers allows the tractor to resume forward travel at speed selected by the FSC lever.

To stop and park, the FSC lever is moved rearward to the **NEUTRAL-PARK** position.

- Blade Clutch (PTO)

Standard 11-HP Model – Lever Behind RH Fender

PTO lever has two positions: Push rearward to **ENGAGE** mower blade drive and pull forward to **DIS-ENGAGE** and activate blade brake.

Commercial 16-HP Model – Toggle Switch on RH Front of Body

The PTO switch has two positions: ON (ENGAGE) and OFF (DISENGAGE) – positioning switch “**ON**” activates the electromagnetic blade drive clutch while the blade brake is applied when the switch is moved to “**OFF**.”

NOTE: On GHS 6.7 Models, the Powerfil motor and “Grass-Pak” full signal switch are activated by engaging the blade clutch (see GHS 6.7 operation description in this section).

- Transmission Unlock – Raise Body/Transmission Case

Hydrostatic transmissions are unlocked to permit freewheeling by lifting lever on top of transmission and locking into place with locking cam. Transmissions are reset by releasing locking cam. See Photo 4-2.

NOTE: Transmission unlock plunger on side of transmission case (activated by unlock lever) must be completely released during operation of mower, otherwise transmission operation will be erratic.

STARTING ENGINE

IMPORTANT: Before operating mower, be sure that you have read and understand “Safety Instructions” given in Section 2, in addition to the “Operating Instructions” presented in this section.

WARNING

Never run the engine in an enclosed or poorly ventilated area. Engine exhaust contains carbon monoxide, an odorless and deadly gas.

- Be sure Forward Speed Control is in **NEUTRAL-PARK** position and blade clutch is **DISENGAGED**.

CAUTION

A safety interlock switch system **PREVENTS CRANKING** the engine with either Forward Speed Control or clutch out of neutral. If the engine cranks otherwise, the safety system is not working and should be repaired or adjusted before operating the mower. **DO NOT disconnect safety switches because they are for the operator’s protection.**

- Move choke lever to “**ON**” position and move throttle lever to ½ throttle.

NOTE: Choke may not be required if engine is warm.

- Turn ignition key to “**START**” and as soon as the engine starts, release key to “**RUN**” position.

IMPORTANT: If engine fails to start after approximately 15 seconds of cranking, the engine should be checked before further cranking. Allow at least a 60-second pause between each cranking attempt to prevent overheating starter motor. Prolonged cranking can damage the starter motor and shorten battery life.

- Gradually move choke to “**OFF**” position, keeping enough choke to allow the engine to run smoothly as it warms up. As soon as possible, move choke to “**OFF**” position.

IMPORTANT: Make sure choke is in “**OFF**” position during normal engine operations; running with choke “**ON**” can damage engine.

ADJUSTING GROUND SPEED AND STEERING

CAUTION

LEARN TO START, STOP AND MANEUVER IN LARGE OPEN AREA.

If operator has not operated a machine with **LEVER STEERING AND/OR HYDROSTATIC TRANSMISSIONS**, the steering and ground operation should be learned and practiced until the operator is completely comfortable handling the machine **BEFORE ATTEMPTING MOWING**.

Beginning recommendations are:

◆ Learn operation in open area away from buildings, fences, obstructions. Learn operation on flat ground **BEFORE OPERATING ON SLOPES**.

◆ Start maneuvering with **SLOW** engine speed and **SLOW Forward Speed Control** setting until familiar with all operating characteristics.

◆ Remember it is not necessary to hold steering levers forward (a unique Walker feature); always **PULL ON LEVERS** for steering or reverse.

◆ Learn to operate with **LEFT HAND ON STEERING LEVERS** and right hand on **Forward Speed Control** as shown by Photo 4-3. Use of two hands on steering lever tends to cause overcontrol.

◆ Learn to operate steering levers with smooth action. Jerky movements are hard on the transmission and lawn. For sharp turns, do not allow inside wheel to stop and twist on grass; pull steering lever controlling inside wheel into reverse for a smooth "rolling" turn (one wheel rolling forward while the other rolls backward).

◆ Practice maneuvering mower until you can make it go exactly where you are aiming.

◆ Remember, for an emergency stop, or in case of loss of control, you can always stop the machine movement quickly by pulling the **Forward Speed Control** into "**NEUTRAL-PARK**" position.

- Move "Forward Speed Control" out of **NEUTRAL-PARK** to desired forward speed. **Do not** hold forward on steering levers. It is not necessary to hold the "Forward Speed Control" lever in position since a friction lock maintains the selected lever position (and forward travel speed).

NOTE: If the FSC is not staying in selected position, the friction lock needs to be adjusted. See Section 5 "Forward Speed Control Lock" adjustment procedure.



PHOTO 4-3 *Correct Operator Hand Position on Controls*

- Steer by pulling lever on side of desired direction of turn, e.g., pull LH lever to turn left. Use one hand on both steering levers as shown by Photo 4-3 to minimize possibility of overcontrol.

- Reverse direction of mower by pulling both levers back.

NOTE: Smooth action on steering levers will produce smooth mower operation; remember to slow down engine and ground speed until operator has learned control response.

- "Forward Speed Control" may be adjusted forward for faster ground speed and back for slower ground speed. When mowing, the ground speed should be adjusted to match the load on the cutter blades, i.e., as engine pulls down in heavy cutting, pull back on FSC lever to reduce ground speed. Adjusting ground speed helps maintain a balance between engine power and blade speed for high quality cutting action.

- Stop ground travel by pulling both steering levers back to neutral (tractor not moving) and then moving "Forward Speed Control" lever to **NEUTRAL-PARK** position.

NOTE: If tractor creeps forward or backward with FSC in **NEUTRAL-PARK**, the transmission control needs to be adjusted. See Section 5 adjustment procedure.

ENGAGING MOWER

- Set engine throttle about ½ speed. **Do not attempt to engage blade clutch at high engine speeds** as this will drastically shorten drive belt life (and electric clutch life on commercial model) – use only moderate engine speed when engaging blade clutch.

- Engage Blade Clutch

Standard 11-HP Model – Move blade clutch lever **SLOWLY** back to engage mower.

Commercial 16-HP Model – Pull out and up on toggle switch.

CAUTION

A safety interlock switch (seat switch) will cause engine to stop if the blade clutch is engaged and the operator is not in the seat. The function of this switch should be checked by operator raising off the seat and engaging blade clutch; the engine should stop. If the switch is not working, it should be repaired or replaced before operating mower. Do not disconnect safety switches because they are for the operator's protection.

IMPORTANT: Do not engage blade clutch when transporting mower across drives, sidewalks, loose materials, etc. Do not engage blade clutch with PTO shaft disconnected (mower deck removed from tractor).

STOPPING

- Slow engine to idle; put throttle in **IDLE** position.
- Pull steering levers to neutral position and then move Forward Speed Control lever back to **NEUTRAL-PARK** position.
- Disengage Blade Clutch

IMPORTANT: Do not disengage clutch with high engine speed (above ½ throttle) since **brake action** on blade drive will cause premature wear of blade drive belts (and electric clutch/brake on commercial model).

WARNING

A brake stops cutter blades (and blower on GHS models) from freewheeling within 5 seconds after disengaging clutch. If the brake system malfunctions – blades do not stop within 5 seconds – the brake should be adjusted or repaired before operating mower. See Section 5 adjustment description.

- Turn Ignition Switch Off

CAUTION

Remove key from ignition switch when leaving mower unattended to prevent children and inexperienced operators from starting engine.

WARNING

The mower uses hydrostatic transmission lock for a parking brake and is not equipped with an auxiliary parking brake. If the mower is parked on a slope, **CHOCK WHEELS TO PREVENT CREEPING MOTION**. This is due to a small amount of slippage of the hydrostatic transmissions especially when the transmission fluid is warm.

CAUTION

If the cutting blades strike a stationary object while mowing, stop mower immediately, disconnect spark plug wire, lift deck and inspect thoroughly for damage. Check that blade timing has not been disturbed (blades should be at 90 degrees to each other, See Figure 4-4). See Section 5, "Replacing Blade Overload Shear Bolts" if blades are out of time. Also check blade retaining nuts are torqued to 60 ft-lbs.

ADJUSTING CUTTING HEIGHT



Engine must be stopped before adjusting cutting height.

Cutting height is adjusted by positioning four re-tainer "Hitch" pins in a series of seven vertical spaced holes on deck support pins. Lift handles have been provided on each end of the deck to assist in raising the deck while positioning hitch pins. Cutting height ranges from 1" (top holes) to 4" (bottom holes) in 1/2" increments.

TRANSMISSION UNLOCK

To move mower without the engine running (dead battery, etc.), the hydrostatic transmissions are unlocked:

- Raise body.
- Lift transmission unlock lever on both RH and LH transmission and secure into place with locking cam (see Photo 4-2).
- Mower will "freewheel" with levers in "UP" position. Levers must be in highest position to completely unlock transmissions.
- After moving mower, release locking cam, placing lever "DOWN" in normal operating position. Check that the transmission unlock plunger on side of transmission case (activated by unlock lever) is **completely released**, otherwise transmission operation will be erratic.

RECOMMENDATIONS FOR MOWING

- Keep mower deck and discharge chute clean.
- Mow with sharp blades. A dull blade will tear grass, resulting in poor lawn appearance and also takes extra power (slows mowing speed).
- When using side discharge mower deck, the discharge shield **must not be removed** and must be kept in lowest possible position to deflect grass clippings and thrown objects downward. Orient side discharge away from sidewalks or street to minimize cleanup of clippings. When mowing close to obstacles, orient side discharge away from obstacles to reduce chance of damage to property by thrown objects.

- It is preferable to cut grass when it is dry and not too tall. Mow frequently and do not cut grass too short (for best appearance cut off 1/3 or less of the existing grass height).

- When mowing, operate engine at or near full throttle for best cutting action and performance of grass handling system (GHS). Mowing with a lower engine RPM causes the mowing blade to not cut clean and tear the grass. The engine is designed to be operated at full speed.

- When mowing in adverse conditions (tall and/or wet grass), mow grass twice. Raise mower to highest setting (4") for the first pass and then make a second pass cutting to desired height.

- Use slow setting on "Forward Speed Control" for trimming operations.

- Be sure mower is leveled properly for a smooth cut (see Step 5 of the set-up instructions in Section 3).

- Use alternating stripe mowing pattern for best appearance and vary direction of stripe each time grass is mowed to avoid wear patterns in grass.

- Avoid damaging grass by slipping and skidding drive tires. Use smooth control movements of steering levers since the hydrostatic transmissions are "power boosted controls" and jerking the levers can easily slip the tires. For sharp turns, do not allow inside wheel to stop and twist on grass; pull inside steering lever into reverse for a smooth "rolling" turn (one wheel rolling forward while the other rolls backward).

GHS OPERATION

A. General Information

The GHS (Grass Handling System) consists of a rear discharge mower deck connected to a 9-inch blower and a rear mounted grass catcher of either 3.2 or 6.7 bushel capacity. The GHS blower operates anytime the mower blade clutch is engaged and moves grass through the rear discharge deck chute into the grass catcher. Blower airflow is exhausted out the back of the grass catcher, above a filtering screen. When the catcher is full and needs to be emptied, a "full" signal horn alerts the operator. When the full signal sounds, it is important to stop mowing to prevent overfilling and clogging of the blower system.

IMPORTANT: Normally the GHS blower operates with no maintenance or cleaning required. However, under certain operating conditions, the inside of the blower housing may accumulate a deposit of dirt, causing wear and binding of the blower wheel. Normally the dirt buildup occurs when mowing a **combination of dirty and damp grass**, especially in the springtime. When operating in these conditions, check the blower wheel frequently for binding and clean blower housing per instructions in Section 5 (Clean GHS Blower).

NOTE: When using the GHS mower in autumn to vacuum leaves, it is recommended to raise the front of the mower deck 2-3 notches (1" to 1½") higher than the rear to avoid "bulldozing" the leaves, particularly when the leaves are piled in a thick layer. To make this adjustment, the retainer pins in the **two front** deck support pins are repositioned 2-3 notches higher while leaving the rear pins in original position.

NOTE: When a side discharge mower deck is installed on the GHS model, a blower intake cover (P/N 5595-2) should be installed in the blower intake tube. This cover "unloads" the blower and seals the intake to effectively eliminate power loss and blower noise when the blower is not being used.

DANGER

NEVER OPERATE GHS CATCHER WITH BACK DOOR OPEN – objects may be thrown out back of catcher with sufficient force to cause injury to bystanders or damage property.

DANGER

ROTATING BLOWER BLADES

NEVER OPERATE GHS BLOWER WITH BLOWER DISCHARGE CHUTE UNCOVERED (grass catcher in dump position) since dangerous projectiles may be thrown. NEVER PUT HANDS INTO BLOWER DISCHARGE CHUTE FOR ANY REASON – use stick or similar instrument to remove material if clogging has occurred.

CAUTION

Never leave grass clippings in grass catcher after mowing. Damp clippings generate heat as they decompose which may cause spontaneous combustion.

B. Clogging Checklist

In case of clogging, there will be a distinct change in sound of the blower, i.e., the blower sound will stop. Also, the mower deck will begin to leave a trail of grass clippings. When this occurs, stop the engine, disconnect spark plug wire and make sure all movement has stopped before attempting to unclog.

DANGER

Never place hand under mower deck or in GHS blower discharge chute. Use a stick or similar instrument to remove clogged material.

Normally, clogging will develop at the back of the mower deck in the discharge opening into the blower chute. Clogging at this point **does not indicate a particular problem in this part of the system, but is a symptom of something restricting the flow of material** throughout the entire system. The following list of items should be checked if a pattern of clogging begins to develop. All of these items are capable of causing clogging at the back of the deck.

- Check RH and LH mower blades are installed **for correct rotation** – install blades so cutting edges move towards each other. See Figure 4-4.

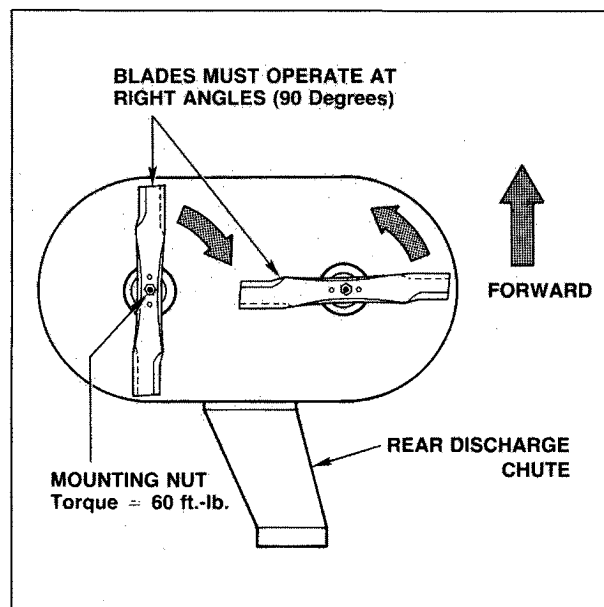

FIGURE 4-4 Blade Rotation for GHS Mower Deck

- Check the amount of **flat section** remaining at blade tip. This area is ground away (removed) when the blades are sharpened and if too much of the flat section is removed, the “air lift” performance or “shovel” effect of the blade deteriorates to the point that discharge of grass clippings into the blower chute is marginal. Replace cutter blades if less than $\frac{3}{4}$ ” flat section remains at blade tip.

- Check the interior of the deck housing and baffling is reasonably **clean and free of grass and dirt buildup**. While some degree of material buildup can be tolerated, a point is finally reached where the flow of air and grass clippings is restricted.

- Check deck cutting height setting. When working in thick, tall grass, **lower deck settings (1"-2") tend to restrict airflow** moving into and under the deck. Raising deck cutting height will significantly increase airflow and reduce clogging when working in thick, tall grass.

- Check the interior of the chute connecting the mower deck to the blower for **smoothness and freedom of obstruction**.

- Check blower wheel for **bent blades and excessive clearance** between blade tip and blower housing – clearance greater than $\frac{1}{8}$ ” will cause a significant loss of blower performance.

- Check blower discharge chute into the grass catcher for **smoothness and freedom from obstruction**.

- Check elbow inside grass catcher for a **buildup of material in radius**. In certain conditions (damp/dirty grass) a considerable “clump” of material can accumulate at this point, greatly restricting material and airflow.

- Check the **openings in the air exhaust screen** in grass catcher are not plugged.

Remember, anything that restricts airflow or material flow along the entire path from mower deck to catcher can cause clogging.

C. Using the 3.2 Bushel Catcher

The GHS 3.2 bushel grass catcher system has a “full signal” horn to alert the operator to dump the catcher when it is full (to prevent overfilling and clogging). When the catcher is full of grass, the air exhaust (out the back of the catcher) is **blocked**

which raises air pressure in the GHS blower; increased air pressure triggers a pressure switch, in turn causing the horn to sound. When the horn sounds, it is important to stop mowing or clogging may result. The following notes apply to correct operation of the full signal:

- To check “full signal horn” function, operate mower with blade clutch engaged and **moderate** engine speed. Block the catcher air exhaust (opening above back door) and the horn should sound. If the horn does not sound, even after increasing engine speed to full throttle or the horn blows continuously, even after decreasing engine speed to idle, then the pressure switch will need to be adjusted per note below.

- The pressure switch which triggers the GHS horn signal has an adjustable set point; use “trial and error” to adjust the horn to sound when the catcher is **almost full**. Adjust the horn signal per the decal located on the pressure switch (the pressure switch is mounted on side of blower discharge chute; raise body for access to switch). Refer to Section 5 “GHS Full Signal Adjustment” for detail adjustment procedure.

NOTE: The horn signal should be adjusted to sound **before the catcher is completely full** to give the operator a little time to react and stop mowing. An indication the horn signal is coming on too late (delayed too much) is if grass clippings are falling out of the grass catcher delivery chute when the catcher is dumped.

- If mowing tall and/or wet grass, the 3.2 bushel catcher may not fill completely before the horn signal comes on (premature signal due to grass clippings “piling” in front of discharge chute). To improve this situation (a) use maximum engine speed, (b) mow grass twice with intermediate and final cutting heights, (c) open tailgate and handpack grass after premature horn signal; resume mowing until catcher is full.

For dumping, the 3.2 catcher either tailgate dumps into a disposal area or dumps directly into a 30 gallon trash bag. Dumping instructions are:

- Raise catcher using handle on lower RH side of catcher mount frame.

- Open catcher tailgate (back door) by releasing two (2) catches on top and lowering tailgate.

- If emptying into trash bag, stretch 30 gallon heavy duty trash bag (4 mil thickness) around catcher opening. Make sure bag is stretched past “barbs” on each corner.

NOTE: When dumping into a trash bag, use only heavy plastic trash bags to avoid tearing when grass is dumped into bag.

- Dump/tilt catcher up by lifting up with handle on front of catcher. See Photo 4-5 for dumping position.



PHOTO 4-5 Dumping 3.2 Bushel Catcher

D. Using the 6.7 Bushel Catcher

The GHS 6.7 bushel catcher has an oscillating grass delivery spout (**POWERFIL**) which is designed to spread grass clippings throughout the interior of the catcher (even when mowing wet heavy grass). The oscillating action may be checked by turning the ignition switch “ON” and moving blade clutch to “EN-GAGED” position. The spout should oscillate approximately 25 cycles per minute.

NOTE: On the Standard Model, if the grass spout fails to oscillate, the clutch switch should be checked for function (on the Standard Model the switch closure is adjustable).

The GHS 6.7 catcher has a “full signal” horn to alert the operator to dump the catcher when it is full (to prevent overfilling and clogging). The “full signal” horn is activated by a vane switch (Grass-Pak switch) mounted on the grass delivery spout. The oscillating action of the spout triggers the vane switch as grass begins to fill in around the spout when the catcher is almost full. The full signal function may be checked by turning ignition switch on and engaging blade clutch (engine not running). Open catcher back door and use hand to trigger “Grass-Pak” vane as it oscillates. Horn should sound as switch is moved in both directions.

WARNING

Do not test Grass-Pak switch with engine running – projectiles may be thrown out of grass delivery spout.

The “full signal” horn is designed to operate (sound) when the catcher is **almost full**. The timing of the signal is adjustable by changing the position of the vane on the Grass-Pak switch. If the signal is coming on too soon (catcher not completely full) or too late (grass clogging in catcher spout and delivery chute), then refer to Section 5 “GHS Full Signal Adjustment” for detail adjustment procedure.

NOTE: The horn signal should be adjusted to sound **before the catcher is completely full** to give the operator a little time to react and stop mowing. An indication the horn signal is coming on too late (delayed too much) is if grass clippings are falling out of the grass catcher delivery chute when the catcher is dumped.

For dumping, the 6.7 catcher either tailgate dumps into a disposal area or dumps into the optional dump bag (P/N 5598). The dump bag is a **reusable** nylon fabric bag designed to conveniently move grass clippings from 6.7 catcher to remote disposal container or area.

◆ **Tailgate dump** – open back door by lifting on door handle. Tilt catcher back to dump by lifting on handle on front of catcher.

◆ **Using P/N 5598 Dump Bag**

- Open back door by lifting on door handle.
- Orient dump bag with one of the handle straps on bag opening facing up.
- Hook bottom of bag over rear bumper while lifting on handle strap as shown by Photo 4-6.
- Tilt catcher back to dump into bag by **lifting on handle** on front of catcher **with left hand** while continuing to **hold up on the bag strap with the right hand**. See Photo 4-7 for dumping position.



PHOTO 4-6 *Positioning Dump Bag on 6.7 Bushel Catcher*



PHOTO 4-7 *Dumping 6.7 Bushel Catcher into Dump Bag*

SECTION 5

Maintenance

| MAINTENANCE CHART - RECOMMENDED SERVICE INTERVALS | | | | | |
|---------------------------------------------------|-------|----------|----------|--------|-----------|
| Service Item | Daily | 10 Hours | 25 Hours | Yearly | Ref. Page |
| Check Crankcase Oil Level | X | | | | 26 |
| Clean Engine Air Cooling System * | X | | | | 29 |
| Clean Grass Buildup Under Deck | X | | | | 29 |
| Clean GHS Blower * | X | | | | 30 |
| Check Battery Electrolyte Level | | X | | | 30 |
| Check Hydrostatic Trans. Fluid | | | X | | 27 |
| Check Tire Pressure | | X | | | 31 |
| Service Mower Blades | | X | | | 31 |
| Check Gearbox Oil Seals | | | X | | 32,27 |
| Lubricate Grease Fittings & Oil Points * | | | X | | 26 |
| Change Engine Crankcase Oil ** | | | X | | 26 |
| Clean Air Filter Element * | | | X | | 29 |
| Check Drive Belts (3) | | | X | | 32 |
| Check Drive Chain Tension/Lubricate | | | X | | 32,27 |
| Replace Air Filter Element | | | | X | 29 |
| Check Spark Plug | | | | X | 32 |
| Clean Engine Cooling Fins | | | | X | 29 |
| Replace Fuel Filter | | | | X | 33 |
| Change Hydrostatic Trans. Fluid *** | | | | X | 28 |
| Service Battery | | | | X | 30 |
| Check Blade Brake Action | | | | X | 32 |
| Check/Adjust FSC Friction Lock | | | | X | 40 |
| Check/Adjust Electric Clutch | | | | X | 40 |

* More Often In Extremely Dusty/Dirty Conditions

** Change Engine Crankcase Oil On New Engine After First 5 Hours Of Break-In Operation

*** Change Every 500 Hours Or 2 Years

CAUTION

When performing maintenance with mower body RAISED, a safety prop should be installed from back of body to chassis frame (Fail-Safe protection in case of failure of body lift support).

LUBRICATION

A. Engine Break-In Oil

No special break-in oil is required. Engine is serviced with 30W, service class SF oil from factory. Change engine oil after first 5 hours operation.

B. Check Engine Crankcase Oil Level

- Park mower on **level** surface with engine stopped. Also make sure the engine is cool and oil has had time to drain into sump.

IMPORTANT: Never attempt to check or add oil with engine running.

- Before removing dipstick, clean area around fill tube to keep dirt and debris out of engine.

- Remove fill cap/dipstick, wipe with clean rag, reinsert the dipstick and push it all the way down into the tube. Remove the dipstick and check the oil level. Oil level should be within safe range (between "F" and "L" marks on Kohler engine or "Full" and "Add" marks on B & S engine).

IMPORTANT: Do not operate engine with oil level below low mark or above full mark.

- If additional oil is needed, refer to Engine Specifications (Section 1) for proper crankcase lubricant and **fill to full mark**.

IMPORTANT: Do not overfill (oil above full level) as this can result in engine overheating causing loss of power and permanent damage to engine.

C. Change Engine Crankcase Oil

Change engine crankcase oil every 25 hours as follows:

IMPORTANT: Change oil every 10 hours when working in extremely dusty conditions.

- Drain oil when engine is warm. If not warm from use, start engine and run a few minutes to warm oil.

- Remove dipstick and oil drain plug and drain oil into a container.

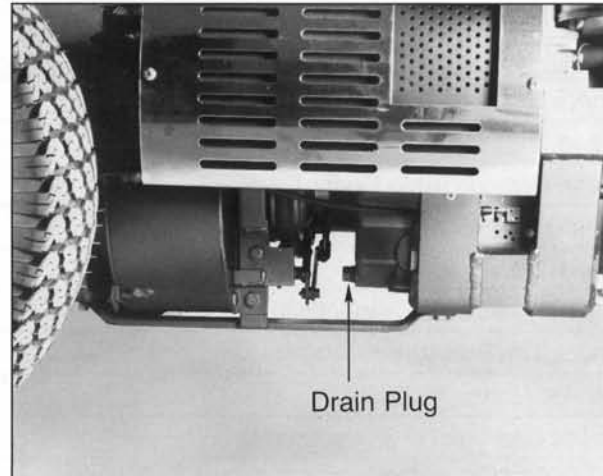

PHOTO 5-1 Oil Drain Location on Standard Model

Standard Model – Drain plug located on front side of engine below engine drive pulley (See Photo 5-1). Place 2x4 board under rear tire to tilt engine slightly toward the oil drain to completely drain oil.

Commercial Model – Drain plug located on bottom of crankcase.

- Install and tighten drain plug.

IMPORTANT: Do not run engine without sufficient oil supply in crankcase.

- Fill crankcase with oil using only crankcase lubricants specified by engine manufacturer (See Section 1 Specifications or Engine Owner's Manual). **Fill to full mark** on dipstick; crankcase capacity is 3 pints for 11-HP B & S engine and 1 $\frac{3}{4}$ quarts for 16-HP Kohler engine.

IMPORTANT: Check dipstick reading before pouring in last $\frac{1}{2}$ pint of oil and **fill only to full mark**. The oil level should never be over full mark on dipstick; overfilling can result in engine overheating causing loss of power and permanent damage to engine.

D. Lubricate Grease Fittings and Oil Points

Lubricate grease fittings and oil points after every 25 hours of operation; more often when operating in dusty or dirty conditions. Use SAE general purpose lithium or molybdenum base grease for grease fittings and light machine oil (SAE 10) to lubricate oil points. Lubricate the locations listed by Table 5-2.

| LOCATION | TYPE LUBRICATION | NO. PLACES |
|------------------------------------------|-------------------|------------|
| Deck Caster Wheel Bearing | Grease Fitting | 2 |
| Deck Caster Wheel Fork Pivot | Grease Fitting | 2 |
| Deck Support Arm Socket | Grease Fitting | 2 |
| Deck Gearbox Spline Coupling | Grease Fitting | * |
| PTO Drive Shaft (Pillowblock Bearing) | See Note Below | 2 |
| Steering Lever Pivot | Grease Fitting | 4 |
| Forward Speed Control Friction Pivot | Grease Fitting | 1 |
| Forward Speed Control Lever Pivot | Grease Fitting | 1 |
| Forward Speed Control Lever Fork | Grease Slide Area | 1 |
| Engine Belt Tightener Pivot | Grease Fitting | 1 |
| PTO Belt Tightener Pivot | Grease Fitting | 1 |
| Transmission Belt Tightener Pivot | Grease Fitting | 1 |
| PTO Clutch Lever Pivot ** | Grease Fitting | 1 |
| Throttle Control Pivot and Cable Ends | Oil | 3 |
| Choke Control Pivot and Cable Ends | Oil | 3 |
| Forward Speed Control Actuator Rod Pins | Oil | 2 |
| PTO Clutch Actuator Rod Pivot & Slide ** | Oil | 2 |
| PTO Belt Scrubber Brake Pivot(s) ** | Oil | 4 |

* 3 Fitting on 36" Deck
4 Fitting on 42" Deck
5 Fitting on 54" Deck

** On Standard 11-HP Model Only

NOTE: If pillowblock bearings on PTO drive shaft are equipped with grease fittings, they are the sealed-relubricatable type and should be lightly greased once per season.

TABLE 5-2 Lubrication Chart

E. Gearbox Lubrication

The tractor right angle gearbox and mower deck gearbox(es) are permanently lubricated (oil filled) and sealed requiring no scheduled lubrication. However, the gearbox oil seals should be checked every 25 hours for indication of oil leaks; particularly the **lower seals on the blade drive gearboxes** should be inspected since they operate in a dirty environment. If evidence of an oil leak is noted, the oil seal will need to be replaced and the gearbox relubricated as follows:

- Clean area around gearbox cover to prevent contaminants from entering gear case.
- Remove screws securing cover to gearbox and remove cover.
- Check level of lubricant in gearbox. If lubricant level is low, add SAE E.P. (extreme pressure) 90W oil until oil level is up to (covers) horizontal shaft of gearbox (shaft parallel to cover).

- Check condition of cover gasket and replace if damaged or worn.

NOTE: If working on blade drive gearbox, the gearbox support cap is removed for access to the gearbox cover. When reinstalling support cap, torque four (4) 1/4-20 mounting nuts to 10 ft.-lb.

F. Lubricate Drive Chain

Every 25 hours lubricate (oil) drive chains. A light penetrating oil or special purpose chain oil is recommended.

G. Check Hydrostatic Transmission Fluid Level

Hydrostatic transmission fluid level should be checked every 25 hours of machine operation. It is preferable to check fluid level when fluid is cold. Check level as follows:

- Park mower on level surface. Stop engine and wipe the dirt and contaminants from around the reservoir cap and air bleed plug. See Photo 5-3 for air bleed plug location.

IMPORTANT: Clean dirt from around reservoir cap before removing it. Any dirt or contaminants entering the transmission will accelerate wear and eventually cause loss of power to drive wheels.

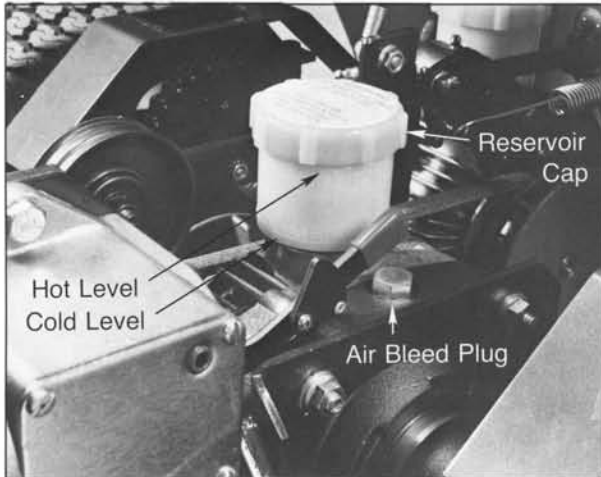

PHOTO 5-3 *Transmission Reservoir and Air Bleed Plug Location*

- Remove reservoir cap and check level of fluid. The reservoir has a fluid level “COLD” mark and “HOT” mark (See Photo 5-3). The reservoir oil level should always be at or above the “COLD” mark and never above the “HOT” mark.
- If fluid is below “COLD” mark (or the transmission is not performing properly), **loosen the air bleed plug** (located on the top of transmission case next to the plastic reservoir, see Photo 5-3); if the **transmission is full** of fluid, a small amount of fluid should leak from around the bleed plug.
- If no fluid leaks from around the bleed plug, slowly add fluid into reservoir and wait until fluid starts to leak from around plug (see notes below). When it is necessary to add fluid, refer to Transmission Specifications (Section 1) for proper fluid; any of the fluids listed may be used; however, transmissions are serviced from the factory with Type SE 20W motor oil. As soon as there is fluid leaking around the air bleed plug, tighten the plug and fill reservoir to the “COLD” level line.

IMPORTANT: Do not overfill transmission reservoir as this will result in oil leaking out of the reservoir cap vent when the transmission warms up. It is preferable to add fluid to the transmission when it is cold and **make sure oil is not above or below “COLD” level mark.**

IMPORTANT: The transmission reservoir has a fine mesh screen in the bottom to trap dirt and foreign particles from entering the transmission. When filling reservoir, fluid will **flow quite slowly** through this screen so it is essential that there is fluid at the bleed plug, before the transmission is considered full.

IMPORTANT: Any attempt to remove or in any way alter the **filtering screen** in the transmission reservoir could cause transmission damage and will void any transmission warranty.

H. *Changing Hydrostatic Transmission Fluid*

Hydrostatic fluid should be changed every 500 hours or 2 years. Also fluid should be changed if the natural color of the fluid has become black or milky (indicating possible overheating or water contamination of fluid). Transmission may be refilled using any of the fluids listed with the Transmission Specifications (see Section 1). The fluid is changed as follows:

- Park mower on level surface, stop engine, remove lower drain plug and air bleed plug and allow fluid to drain out.

IMPORTANT: Clean dirt from around plugs and reservoir cap before removing.

- Reinstall lower drain plug making sure the rubber O-ring on the plug is in place and in good condition.
- Refill transmission through the air bleed plug hole until it is as full as possible. **Rotate the transmission input shaft about five revolutions to allow any trapped air to escape.** Before installing the air bleed plug, fill the reservoir with fluid allowing a small amount to leak out of the bleed plug hole. Install the air bleed plug and fill the reservoir to the “COLD” level line.

CLEANING

A. Clean Engine Air Cooling System

To prevent engine overheating and possible engine damage, clean grass clippings, chaff and dirt from the rotating engine air intake screen every 8 hours of operation. In certain mowing conditions (dry grass, leaves, tree "cotton", etc.) it may be necessary to check and clean this area several times each day to prevent engine overheating. Also, visually check inside cylinder head shroud and between cylinder head fins for material packed in this area which would prevent cooling airflow; remove shroud and clean as required. On the Standard 11-HP Model, an engine screen guard attached to the chassis frame should also be cleaned and kept free of obstruction (see Photo 5-4).

IMPORTANT: Yearly or every 100 hours, remove engine cooling shroud and clean cylinder head cooling fins to prevent overheating. Make sure cooling shroud is reinstalled properly.

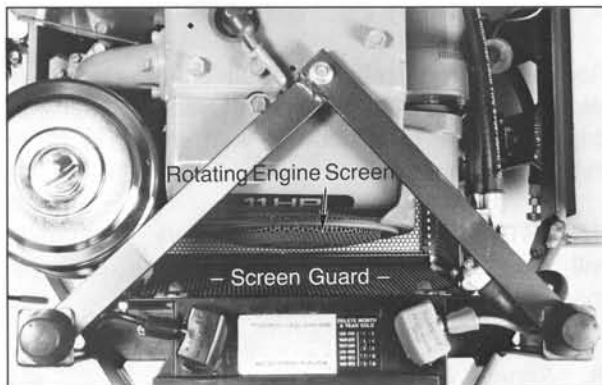

PHOTO 5-4 *Keep Engine Screen and Screen Guard Clean (Standard Model Shown)*

B. Clean/Replace Carburetor Air Filter

The engine is equipped with a paper air cleaner element with an oiled foam pre-cleaner which surrounds the paper element. Clean and re-oil the foam pre-cleaner every 25 hours; more often in dusty/dirty conditions. Clean the paper element every 25 hours and replace yearly (or when dirty or damaged). Service the air filter as follows:

- Remove air cleaner cover and remove foam pre-cleaner by sliding it off the paper element.

- Wash foam pre-cleaner in kerosene or liquid detergent and warm water.

- Wrap foam pre-cleaner in cloth and squeeze dry (do not wring).

- **Saturate foam in clean engine oil.** Squeeze foam to distribute and remove excess oil.

- Remove paper element and clean by tapping gently on flat surface to dislodge dirt. Replace element if dirty or damaged.

IMPORTANT: Do not wash the paper element or do not clean with pressurized air. Do not oil paper element.

- Install foam pre-cleaner over dry element and reassemble onto engine. Tighten nut mounting air cleaner element securely, $\frac{1}{2}$ to 1 turn after contacting cover, but do not over-tighten. Make sure element is sealed tightly against the element cover and base plate. Reinstall air cleaner cover.

C. Clean Grass Buildup in Mower Housing

- Stop engine, remove ignition key and disconnect spark plug wire before raising mower deck for cleaning.

- Raise deck and secure in raised position by hooking the deck lift rod into the body bracket below the counterweight spring clip. See Photo 3-8. The rod is hinged and is stowed along the footrest of the deck carrier frame.

 **DANGER**

Never operate cutter blades with deck in raised position because it is hazardous.

- Clean grass buildup underneath deck using pressure washer (and scraper if required).

NOTE: While some degree of material buildup in the mower deck housing can be tolerated, a point is finally reached **where cutting quality deteriorates and clogging begins to occur** with too much buildup on baffling and housing.

D. Clean GHS Blower

Normally the GHS blower operates with no maintenance or cleaning. However, when mowing grass that is dirty and damp (especially springtime mowing), a deposit of dirt may accumulate inside the blower housing causing wear and binding of the blower wheel. When operating in these conditions, inspect the blower frequently for dirt buildup (Note: A visual clue of binding of the blower wheel is blower blade tips are polished from rubbing on dirt). When a dirt deposit is found, a high pressure washer or water spray is used to clean the inside of the housing using the following procedure:

- Stop engine, remove ignition key and disconnect spark plug wire before attempting to wash blower.
- Remove GHS Blower Drive Belt(s)

Standard 11-HP Model – Move blade clutch (in direction of engagement) far enough to relax belt scrubber brake without tightening the PTO drive belt. Roll belt off blower pulley, then move blade clutch to full “engagement” position. Both drive belt and scrubber brake bar should be clear of blower pulley, allowing free movement of blower wheel.

Commercial 16-HP Model – Unhook PTO belt tension spring from lower hook on blower skid bar. See Photo 5-5. Unlock PTO belt tightener by rotating locking cam as shown by Photo 5-5, then collapse belt tightener idler pulley and roll belts off blower pulley. Drive belts should be clear of blower pulley, allowing free movement of blower wheel.

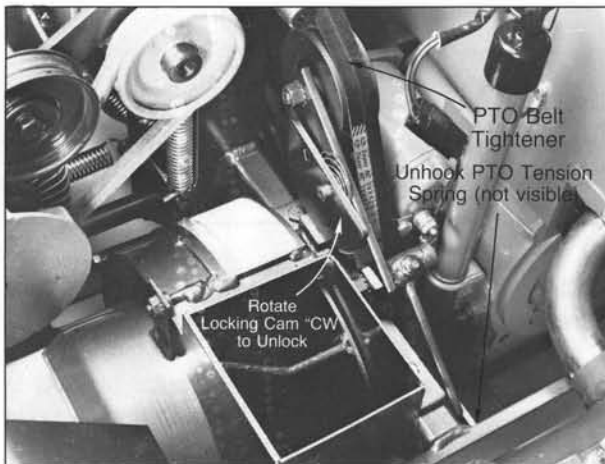

PHOTO 5-5 Collapse PTO Belt Tightener to Remove Blower Belts (Commercial Model)

IMPORTANT: With drive belts removed, the blower wheel **must spin freely**. Any binding or dragging of the wheel is an indication of dirt buildup that must be cleaned to avoid abrasive wear of blower blades, excessive power loss and eventual loss of blower performance (clogging).

- Use pressure washer and direct spray inside blower housing against blower blades. Water pressure will cause blower wheel to begin to spin and the combination of spinning action and water will effectively wash inside of housing. Spray may be directed against blower blades vertically and horizontally to cause rotation in both directions for thorough washing action. Wash blower until blower wheel spins freely in both directions.
- Reinstall blower drive belt(s) by reversing procedure described in paragraph (2).

CHECKING/SERVICING

A. Check Battery Electrolyte Level

Remove battery cell caps and check electrolyte level. If level is below bottom of vent well, fill with drinking water to bottom of vent wells ($\frac{1}{4}$ to $\frac{1}{2}$ Inch above plates).

IMPORTANT: Do not overfill battery. Electrolyte will overflow through vent tube onto parts of machine resulting in severe corrosion.

B. Service Battery

If battery terminals are corroded, remove battery from mower. Using a wire brush, remove corrosion with a solution of one part baking soda and four parts water. Rinse with clean water. Coat terminals with petroleum jelly or terminal protector spray to retard further corrosion.

Check battery charge by measuring specific gravity of electrolyte; if specific gravity is less than 1.225, the battery will need to be charged. Charge battery at 15 amps for 10 minutes. **Do not** exceed 20 amps maximum recommended charging rate. Charge until specific gravity is at least 1.250. Total charging time should not exceed 1 hour.

⚠ DANGER

BATTERIES PRODUCE EXPLOSIVE GASES

- Charge battery in a well ventilated space so gases produced while charging can dissipate.
- Keep sparks, flame, smoking materials away from battery at all times.
- Make sure manifold vent of battery is open (check manifold vent on negative terminal end of battery).

C. Check Tire Pressure

Inflate tires to pressures shown below:

| | |
|------------------------|--------|
| Deck Caster Tire | 20 PSI |
| (Optional Pneumatic) | |
| Drive Tire | 15 PSI |
| Rear Tire | 20 PSI |

D. Check/Sharpen Mower Blades

Check mower blade(s) for straightness, sharpness and condition of cutting edge every 10 hours of operation (or more often when mowing abrasive type grass or operating on sandy soils). Blades will need to be replaced if worn, bent, cracked or otherwise damaged as described by blade replacement instructions in this section (Page 34). The following procedure is used to check and sharpen blades:

- Stop engine, remove ignition key and disconnect spark plug wire before raising mower deck to service blades.
- Raise deck and secure in raised position by hooking deck lift rod into the body bracket below the counterweight spring clip. See Photo 3-8. The rod is hinged and is stowed along the footrest of the deck carrier frame.

⚠ DANGER

Never operate cutter blades with deck in raised position because it is hazardous.

- Check blades for straightness by marking blade tip position inside deck housing and then rotating opposite end of blade to same position and comparing. If the difference in blade tip track is more than 1/8", the blade is bent and should be replaced.

⚠ WARNING

Do not try to straighten a blade that is bent, and never weld a broken or cracked blade. Always replace with a new blade to assure safety.

- If blade cutting edge is dull or nicked, it should be sharpened. Remove blades for sharpening by grasping end of blade using a rag or thickly padded glove while loosening and removing the nut, lock washer and flat washer mouting the blade.

NOTE: Keep blades sharp – cutting with dull blades not only yields a poor mowing job but slows cutting speed of mower and causes extra wear on the engine and blade drive by pulling hard.

- Grind cutting edge at same bevel as original. See Figure 5-6. Sharpen only top of cutting edge to maintain sharpness.

⚠ CAUTION

Always wear eye protection and gloves when sharpening blade.

NOTE: Blades can be sharpened with an electric blade sharpener, conventional electric grinder or a hand file.

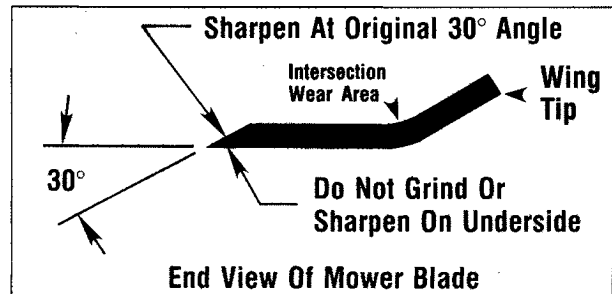

FIGURE 5-6 Mower Blade Profile For Sharpening

- Check blade balance by positioning **horizontally** on a blade balancer or use a nail or shaft through the center hole. See Photo 5-7. If either end of the blade rotates downward, grind (remove) metal on that end until blade will balance; blade is properly balanced when neither end drops. Balance of blade is generally maintained by removing an equal amount of material from each end of blade when sharpening.

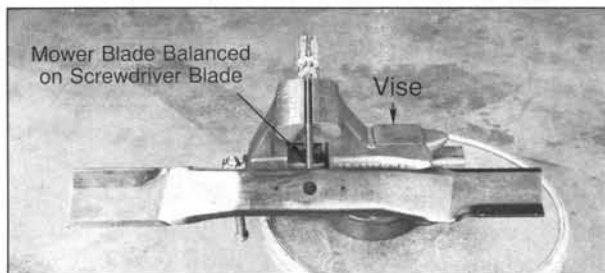

PHOTO 5-7 *Checking Blade Balance*

- Mount blade with blade wing tips pointing up into housing. Reinstall blade, washer, lock washer and nut. **Tighten nut to 60 ft.-lbs.**

NOTE: When reinstalling blades on GHS models, remember blades turn toward each other (counter-rotate) and the RH and LH blade cannot be switched. Check for proper blade rotation before installing blades on deck. See Figure 4-4 for reference.

E. *Check Drive Belts*

Raise body and inspect condition of three individual or sets of drive belts every 25 hours of operation – **engine, PTO drive and ground drive**. If belts show signs of cracking or deteriorating, the belts should be replaced. See “Replacing Drive Belt” instructions in this Section (Page 33).

F. *Check Blade Drive Gearbox Oil Seal*

The lower oil seal on the blade drive gearbox should be inspected every 25 hours for evidence of oil leaking. This seal is protected by the trash guard on the blade hub, but is still vulnerable to seal damage due to operating in adverse environment. The mower blade must be removed for inspection of the seal so it is recommended the seal be inspected when the blades are removed for sharpening (See Paragraph D). If an oil seal is leaking, the seal should be replaced and the gearbox relubricated per “Gearbox Lubrication Instructions” in Lubrication Section (Page 27).

G. *Check Drive Chain Tension*

Check first and second stage final drive chain tension. Chain flex on slack side should not exceed 1/2” at midspan. To adjust tension see “Chain Adjustment” in Adjustment Section (Page 38).

It is important to check and adjust chain tension after initial 10-15 hours operation due to normal “stretching” of new chain and thereafter, check tension every 25 hours.

IMPORTANT: The chain sprockets wear rapidly when operating with loose chains. Regular inspection and tensioning of chains when required will greatly increase sprocket life.

H. *Check/Replace Spark Plug*

Yearly or every 100 hours, remove the spark plug, inspect, clean and reset gap or replace with a new plug. Clean spark plug with wire brush. If electrodes are burned short or pitted, replace the plug. See Engine Specifications (Section 1) for proper type of replacement plug. Check spark plug gap with a wire-type feeler gauge and set gap to 0.030 inch for Briggs & Stratton and 0.025 inch for Kohler.

I. *Check Breaker Points*

Both Briggs & Stratton and Kohler engines are equipped with electronic magneto ignition. No breaker points, maintenance or adjustments are necessary with this system. See your authorized engine dealer in case of ignition failure.

E. *Check Blade Brake Action*

Check function of cutter blade brake (and blower brake on GHS models) by engaging PTO clutch, operating engine at full throttle, then disengaging clutch and measuring how quickly the blades stop. Watch the rotation of the blade drive shaft and blower pulley as a visual indication that movement has stopped; if the brake is working properly, all rotation will stop 5 seconds after disengagement of clutch. If the brake system malfunctions – blades do not stop in 5 seconds – the brake should be adjusted or repaired before operating the mower. See adjustment procedure described in this section (Page 43).

REPLACEMENT/REPAIR INSTRUCTIONS

A. Replacing Drive Belts

Each of three (3) sets or individual belts may be removed and replaced as follows:

| Belt | Action |
|----------------------------------------------|-----------------------------------------------------------------------------------------------------------------------------------------------------------------------------------------------------------------------------------------------------------------------------------------------------------------------------------------------------------------------------------------------------------------------------------------------------------------------------------------------------------------------------------------------------------------------------------------------------------------------|
| Engine Belt(s) Both Models | Push spring loaded idler to relax belt and slide off pulleys |
| PTO Drive Belt Standard 11-HP Model | <ol style="list-style-type: none"> 1) Remove engine belt as noted above. 2) Remove 1/4-20 x 3/4 bolt locating belt guide on gearbox pulley and rotate guide to clear belt; slide belt off of gearbox pulley. 3) Move blade clutch (in direction of engagement) far enough to relax belt scrubber brake without tightening the PTO belt. Roll belt off PTO drive pulley and GHS blower pulley (GHS model only). |
| PTO Drive Belts Commercial 16-HP Model | <ol style="list-style-type: none"> 1) Unhook PTO belt tension spring from lower hook on blower skid bar. See Photo 5-5. Unlock PTO belt tightener by rotating locking cam as shown by Photo 5-5. Then collapse belt tightener idler pulley and roll belts off PTO drive pulley and GHS blower pulley (GHS model only). 2) Disconnect electric clutch wires at connector plug and disengage the clutch restraint strut by pulling back on the strut (against spring pressure). See Photo 5-8. Move belts over clutch assembly (rotate body of clutch slightly to provide clearance for belts). |
| Ground Drive Belt Both Models | Raise spring loaded idler to relax belt and slide off pulleys. |

B. Replacing Blade Overload Shear Bolts

The cutting blade is keyed to blade hub by two shear bolts (10-24 x 5/8 machine screw). These bolts are designed to shear and protect the blade drive gearbox from damage if the blade encounters a shock load (Note: **Tightening the 5/8-18 blade**

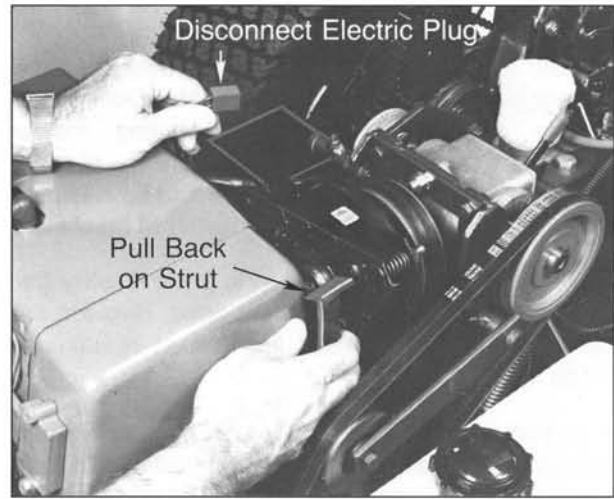

PHOTO 5-8 *Disconnect Electric Clutch for PTO Belt Removal*

mounting nut to 60 ft.-lb. is also important for proper shock load protection). If these bolts shear, remove blade and install new bolts (see "Check/Sharpen Mower Blades" page 31 for blade removal and installation instructions). After reinstalling blade, check blade timing by moving blades through one complete revolution and making sure blade tips pass clear of each other. If timing is incorrect, see "Gearbox Replacement Instructions", page 35.

C. Replacing Fuel Filter

Each year replace the in-line fuel filter. See Photo 5-9.

- Close fuel tank shut-off valve.
- Expand and slide clamps on either side of filter away from filter and pull fuel lines off filter.
- Replace filter.



PHOTO 5-9 *Fuel Filter Location (Standard Model Shown)*

D. Replacing Mower Blades

Mower blades are removed as described by "Check/Sharpen Blades" page 31. During the course of sharpening and inspecting mower blades, if any of the following conditions of wear or damage are noted, the blade should be replaced for reasons of safety and performance of machine:

- The flat section of the blade is ground away (removed) when the blade is sharpened. Replace the blade when less than $\frac{3}{4}$ " flat section remains at blade tip.
- Examine ends of blade carefully, especially intersection where flat section of blade turns up to form "wing tip." See Figure 5-6. Since sand and abrasive material can wear metal away in this area, the blade should be replaced when metal thickness has worn to $\frac{1}{16}$ " or less.



DANGER

When blades are operated over sandy soil, and if blades are allowed to wear, a "slot" may be worn into the wing tip of blade. Eventually a piece of the blade may break off creating a serious potential for injury or damage.

- Check blades for straightness by marking blade tip position inside deck housing and then rotating opposite end of blade to same position and comparing. If the difference in blade tip track is more than $\frac{1}{8}$ ", the blade is bent and should be replaced.
- Inspect blade surface, especially in formed areas, for cracks. Any cracks found are cause for replacing the blade.



WARNING

Do not try to straighten a blade that is bent, and never weld a broken or cracked blade. Always replace with a new blade to assure safety.

Reinstall blades per description "Check/Sharpen Mower Blades" page 31. If blades are replaced, always use **Walker original equipment blades** to

be sure of safety and optimum performance. The quality and performance of replacement blades offered by other manufacturers cannot be guaranteed, **they could be dangerous.**

E. Replacing Electric Clutch (Commercial Model Only)

- Disconnect electric clutch wires at connector plug and disconnect the clutch restraint strut by pulling back on the strut (against spring pressure). See Photo 5-8.
 - Remove all drive belts (engine, PTO and ground drive) per instructions given by "Replacing Drive Belts" on page 33.
 - Remove three (3) bolts (two upper and one lower) mounting gearbox into chassis and lift gearbox/clutch assembly out of chassis.
 - Remove bolt and washers securing clutch onto gearbox shaft. Slide clutch assembly off shaft (clutch has sliding fit on shaft and only light pressure should be required to disassemble). Remove key out of keyway.
 - Remove four (4) cap screws mounting clutch pulley and re-mount pulley on new clutch assembly.
 - Slide new clutch assembly on gearbox shaft. Make sure $1\frac{3}{8}$ " x $\frac{1}{4}$ " retainer washer is on shaft **before the clutch is installed**. Also, **do not** install key in keyway until after the clutch is in position on shaft.
 - Drive key into keyway.
 - Install clutch mounting bolt including $1\frac{3}{8}$ " x $\frac{1}{4}$ " retainer washer and lock washer and torque bolt to 31 ft.-lbs. Visually check that inner bearing race is clamped tight and is turning with shaft.
- IMPORTANT:** The special $\frac{1}{4}$ " retainer washers (Walker P/N 5843-1 and 5843-2) on either side of clutch must be in place and the mounting bolt properly tightened to clamp clutch bearing inner race. Failure to do so will result in premature wear and damage to clutch assembly.
- Check and adjust clutch airgap. See instructions for clutch adjustment, page 40.
 - Reinstall clutch/gearbox assembly into chassis. Install drive belts, clutch restraint strut and connect electric plug to complete installation.

F. Replacing Mower Deck Gearbox(es)

NOTE: Deck gearboxes may be changed with the deck mounted on the tractor. However, as an alternate approach, the deck may be removed from tractor, perhaps making the overall job of removing gearboxes easier. Refer to Section 3 "Install Mower Deck" and reverse procedure to remove deck.

- Remove mower blade as described by "Check/Sharpen Blades" page 31.
- Remove gearbox cover (two machine screws).
- Remove gearbox support cap by loosening four (4) ¼-20 elastic stop nuts.
- If the gearbox to be removed is either the **outside end blade drive** on the 54SD deck or the **LH end gearbox** on all other decks, the gearbox can be removed by disconnecting the spline coupling on spline shaft and lifting the gearbox straight up as follows (See Photo 5-10):
 - ◆ Remove gearbox mounting bolts.
 - ◆ Drive E-ring retainer out of groove in spline shaft.
 - ◆ Slide coupling away from gearbox to expose spline joint.
 - ◆ Lift gearbox straight up to remove.

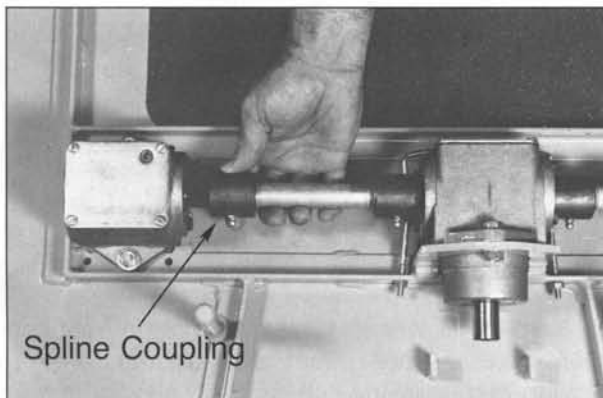

PHOTO 5-10 Gearbox Spline Coupling Removal

- If gearboxes are mounted close together (all except those described by previous paragraph), the "Tee" gearbox and adjacent right angle gearbox **will have to be removed together** as follows:

- ◆ Remove all gearbox mounting bolts including the U-bolt on the "Tee" gearbox.
- ◆ Remove PTO shaft cover (two bolts).
- ◆ Remove PTO shaft from "Tee" gearbox.
- ◆ Drive E-ring retainer out of groove in spline shaft on **LH side** of Tee gearbox for all decks except 54SD; on 54SD remove E-ring on RH end of Tee gearbox and LH end of center blade drive gearbox.
- ◆ Slide coupling(s) away from gearbox to expose spline joint.
- ◆ Lift and tilt the two gearboxes together to remove out of mounting position.
- To reinstall gearbox(es), position gearboxes and install all mounting bolts in place but not completely tight (only snug). Also, install connector shaft(s) and slide spline couplings in place (do not install E-rings). Establish correct "timing" of blade drive gearboxes by setting flats on output shaft at 90° when connecting spline couplings.
- Align fore and aft mounting position of gearboxes on outside end by using a straight edge placed on spline couplings. See Photo 5-11.

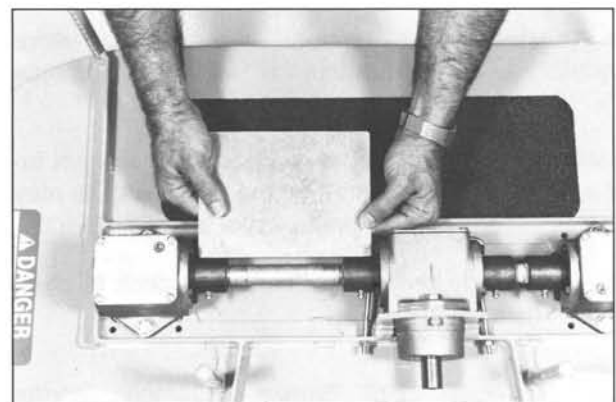

PHOTO 5-11 Align Gearbox Mounting Position Using Straight Edge

- Align "Twist" of outside gearboxes using a square placed on the gearbox bearing cap aligned with the angle iron frame on deck. See Photo 5-12.

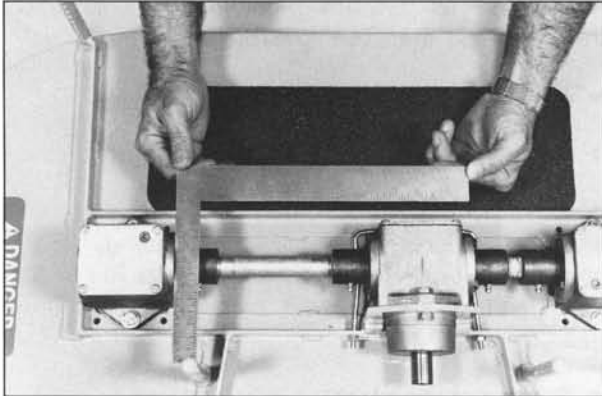

PHOTO 5-12 *Align Gearbox with Deck Frame*

- When outside gearbox alignment has been established in both directions as described by the two previous steps, tighten mounting bolts.
- Align vertical position of Tee gearbox by placing a straight edge on top of spline couplings and then tighten Tee gearbox mounting bolts.
- Test the alignment of all gearboxes by sliding spline couplings – each coupling **should move freely** after being rotated to several different positions. **If any binding is noted, the alignment is not correct and should be readjusted by the preceding instructions.**
- Install E-ring retainers on couplings and lubricate spline couplings by grease fitting.
- Reinstall gearbox support cap on blade drive gearboxes and torque four (4) ¼-20 mounting nuts to 10 ft.-lb.

IMPORTANT: If gearbox support caps are not installed or properly tightened, the gearbox case may break when mower blades strike a solid object.

- Reassemble remaining items onto deck to complete installation.

G. Replacing GHS Blower Assembly (and/or Blower Wheel)

- Remove mower deck. Refer to Section 3 “Install Mower Deck” and reverse procedure to remove deck.
- Remove blower faceplate by removing six (6) ¼-20 nuts.

- Remove blower assembly from chassis as follows:

Standard Model (See Photo 5-13)

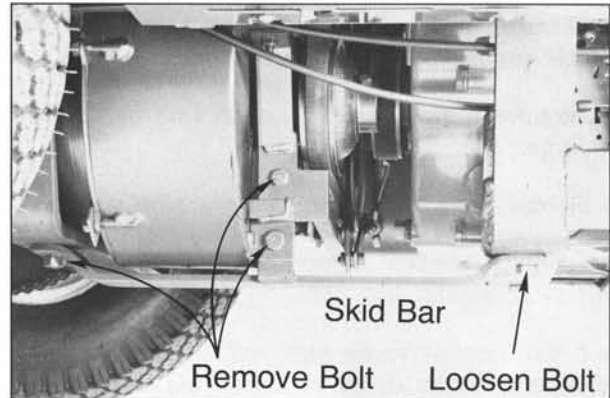

PHOTO 5-13 *GHS Blower Mount Disassembly for Blower Removal*

- ◆ Remove bolt on front of skid bar (underneath blower) connecting skid bar to frame and bolt connecting lower blower housing to skid bar. Loosen rear bolt on skid bar (engine mount) and rotate bar to side (clear of blower assembly).
- ◆ Remove two (2) bolts mounting blower housing to frame and the bolt mounting the scrubber brake assembly on the blower housing.
- ◆ Remove scrubber brake assembly, and roll blower drive belt off pulley.
- ◆ Lower blower assembly straight down out of chassis frame and remove.

Commercial Model

- ◆ Remove blower drive belts by instructions “Replacing Drive Belts” on page 33.
- ◆ Remove blower skid bar by removing front and rear mounting bolts from skid bar (underneath blower) and removing bolt connecting lower blower housing to skid bar.
- ◆ Remove two (2) bolts mounting blower housing to frame.
- ◆ Lower blower assembly straight down out of chassis frame and remove.

- If it is required to replace the blower wheel, the following procedure is used to remove the wheel:

- ◆ Loosen blower pulley set screws and remove pulley using wheel puller.

- ◆ Remove locking collar from back bearing (closest to pulley) by loosening set screw and rotating collar CCW (use punch to drive).

- ◆ Press blower wheel out of housing using wheel puller hooked to lugs on bearing housing. See Photo 5-14. The bearings have been secured in housing with a retaining compound "Loctite RC/680", and **considerable force** will be required to break this bond. After bearings have "broken loose" from housing, only light pressure should be required to remove wheel assembly out of housing.

NOTE: It may or may not be possible to remove the front bearing from the blower wheel without damaging it. If bearing is damaged, it will need to be replaced along with the wheel.

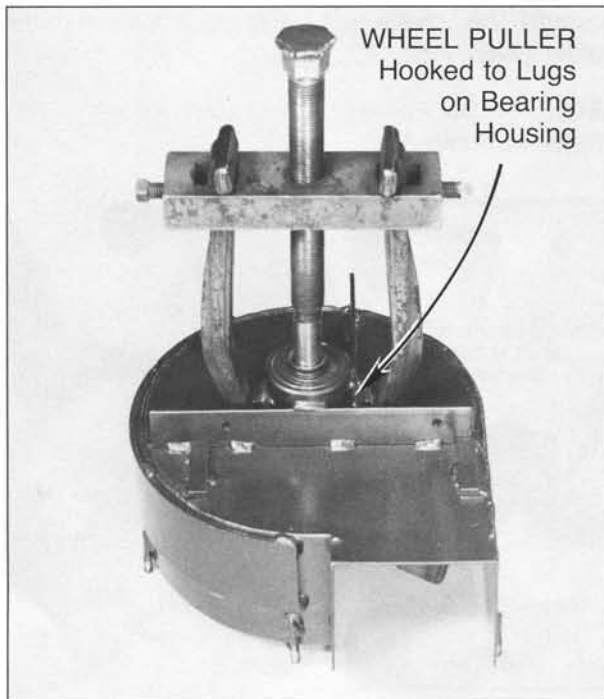

PHOTO 5-14 Pressing Blower Wheel Out of Housing

- To reassemble blower, use reverse procedure. The front bearing is mounted on the blower wheel shaft, secured by locking collar. Drive locking collar clockwise with punch and tighten set screw.

- Press blower wheel and front bearing into blower housing. Use "Loctite RC/680" retaining compound on outer bearing race and inside bearing housing. The rear bearing is pressed into place next, again using Loctite on both outer bearing race and housing. The locking collar is installed on rear bearing and the blower pulley installed to complete blower assembly.

- Reinstall blower into mower using reverse procedures.

H. Replacing Compound Sprocket (Photo 5-15)

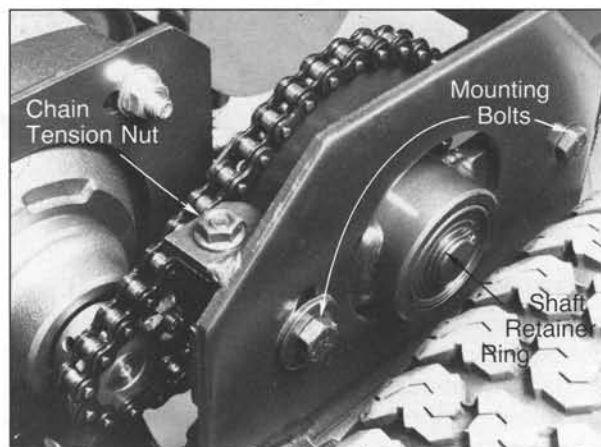

PHOTO 5-15 Compound Sprocket/Jackshaft Assembly

- Disconnect and remove both chains.

- Remove two (2) bolts mounting jackshaft support assembly and chain tension nut and remove jackshaft assembly.

- Remove retainer snap ring on sprocket shaft (end of shaft opposite sprockets).

- Press sprocket assembly out of bearings. The bearing inner race has been secured to the shaft with a retaining compound "Loctite Threadlocker 242" and **considerable force** may be required to break this bond. After shaft has broken loose from bearings, only light pressure should be required to press shaft out of bearings.

NOTE: The “Loctite” compound may be softened by applying heat to the end of the shaft to assist in pressing shaft out of bearings. However, care should be exercised to not apply heat to bearings as they may be damaged.

- If bearings are to be replaced, either bearing may be pressed out of the housing first by pushing on the inner race. Then remove the internal snap ring and press the other bearing out. The bearings are secured in the housing using the same “Loctite” retaining compound as above. Heating the housing may assist in breaking the retaining compound loose when pressing the bearings out.

- To reassemble jackshaft/compound sprocket, reverse preceding steps. Use of “Loctite Threadlocker 242” is recommended to secure both outer bearing race to housing and inner race to compound sprocket shaft.

ADJUSTMENT

A. Final Drive Chain Tension

NOTE: Both final drive chains should be tensioned to flex $\frac{1}{4}$ " to $\frac{1}{2}$ " at midspan on the slack side.

NOTE: When adjustment is required, adjust second stage chain (chain driving axle) first and recheck first stage tension before adjusting first stage. This sequence is recommended since **second stage adjustment also provides some adjustment of first stage.**

● Second Stage Adjustment

- ◆ Lift chain guard.
- ◆ Loosen two bolts mounting jackshaft assembly. See Photo 5-15.
- ◆ Turn adjustment nut to set proper chain tension. See Photo 5-15.
- ◆ Tighten jackshaft mounting bolts.

● First Stage Adjustment

- ◆ Lift chain guard.
- ◆ Loosen four transmission mounting bolts.
- ◆ Turn adjustment bolt (on side of transmission mount) to set proper tension on chain.

- ◆ Tighten transmission mounting bolts.
- ◆ Close chain guard.

NOTE: The first stage chain adjustment will affect transmission control adjustment. See “Transmission Control Adjustment”, next paragraph, to check for proper adjustment.

B. Transmission Control Adjustment Procedure

IMPORTANT: The proper adjustment of the transmission control stops is essential to efficient operation and life of transmission. These stops are properly adjusted at the factory and should only require readjustment if the transmission or related control linkage is removed or changed.

NOTE: It would not be unusual for a new machine after initial 5 or 10 hours of operation to begin to not travel straight (this is due to break-in of transmissions). In this case, proceed to Step (4) instructions and adjust for straight ground travel.

NOTE: The following adjustment procedure is sequential, i.e., check and adjust each function in the order given.

STEP 1 Set Forward Travel Limit (Stop)

Refer to Photo 5-16.



PHOTO 5-16 Forward Speed Control Stop and Steering Lever Adjustment

- ◆ Move Forward Speed Control to most forward position.

◆ Check clearance of RH and LH steering lever actuator arms with frame and **adjust forward stop bolt** so each lever clears frame by at least $\frac{1}{16}$ ". Clearance of arm to frame should be checked while **applying pressure back** on arm to remove any slack in linkage.

◆ Tighten jam nut on forward stop adjusting bolt.

STEP 2 Adjust Steering Lever End Play
Refer to Photo 5-16.

◆ Position Forward Speed Control to most forward position.

◆ Loosen adjustment nut on each steering lever actuator until end play develops between lever actuator and adjustment nut (sliding on transmission control rod).

◆ Hold actuator back (against spring pressure) as shown by Photo 5-16 and tighten nut to point where end play is removed and **then tighten two additional turns**.

IMPORTANT: If **adjustment nut is too loose** (end play exists), excessive loads are placed on transmission internal control stops. If **adjustment nut is too tight** (preferred condition), maximum forward travel speed is reduced.

STEP 3 Adjust Neutral Function
Refer to Photo 5-17

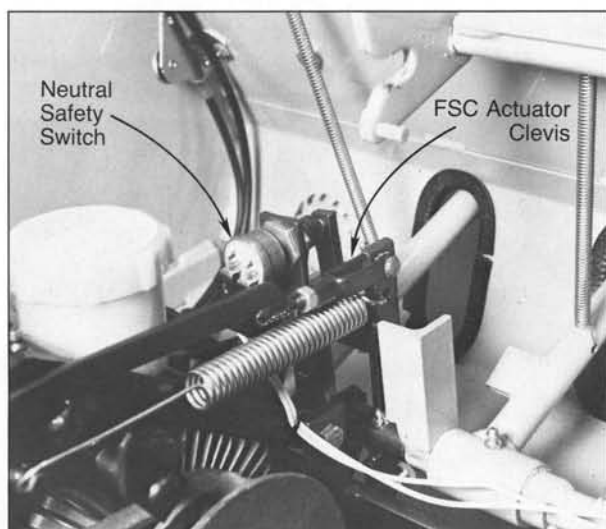

PHOTO 5-17 *Transmission Neutral Adjustment*

◆ Move Forward Speed Control to "Neutral-Park" position (rear travel limit).

◆ Start engine (operate first at idle and then normal operating speeds) and **check for movement of drive wheels**.

NOTE: If engine will not start, check and adjust neutral safety switch (see second paragraph below).

◆ If movement is occurring, stop engine and adjust Forward Speed Control neutral stop by adjusting FSC actuator clevis (See Photo 5-17). The cotter pin and clevis pin are removed and the clevis is screwed forward if wheels are moving backward and vice versa. Restart engine and check for wheel movement (several "trial and error" adjustments may be required). At this point it may not be possible to adjust **both** wheels stationary since the differential adjustment has not been made (See Step 4). In this case, the adjustment should be made for one wheel stationary and the other moving **forward** slightly.

◆ Check and adjust neutral safety switch for closure and function with Forward Speed Control in neutral (engine will not start when switch is open). Use panel nuts on switch body to adjust switch position for closure in neutral.

STEP 4 Adjust for Straight Ground Travel
Refer to Photo 5-18

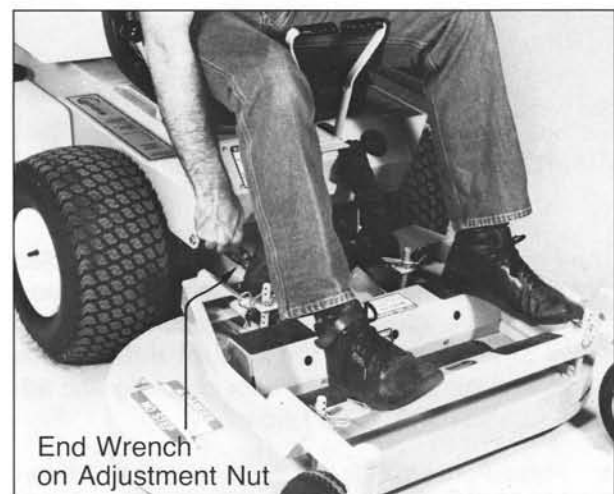

PHOTO 5-18 *Adjust Transmissions for Straight Travel*

◆ Sit in seat, start engine (operate at normal speed) and with Forward Speed Control in “Neutral-Park” check for **forward movement** of either drive wheel (neither wheel should move backward or return to Step 3 and readjust). **Tighten steering lever adjustment nut on side with wheel moving forward** until movement stops.

◆ Check for straight ground track on level surface (with hands off steering levers). Set Forward Speed Control at several different speeds and observe if mower moves in straight line (use cement joint or other line on ground for reference).

◆ If travel is not straight, **tighten adjustment nut on side of wheel moving too fast**, e.g., mower tracks to right, tighten LH adjustment nut.

NOTE: This adjustment should be accomplished with mower moving since the adjustment is quite sensitive and more easily “fine tuned” when moving.

C. Forward Speed Control Lock

Refer to Photo 5-19

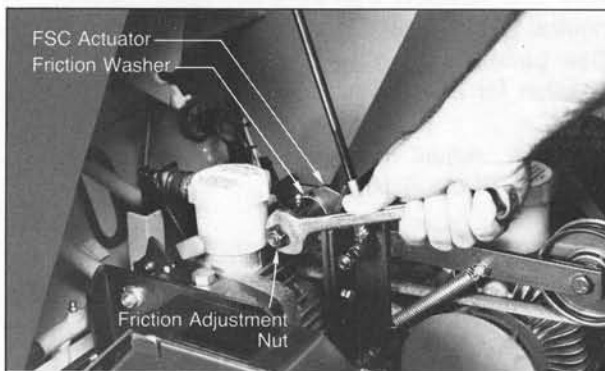

PHOTO 5-19 Forward Speed Control Friction Lock

The Forward Speed Control friction lock is adjusted to **hold the selected forward speed** when steering levers are moved and yet friction is not too heavy to make **moving the control difficult** (too much friction). The procedure for checking and adjusting friction lock is as follows:

1. Place Forward Speed Control (FSC) in full forward position and pull both steering levers back; the FSC lever should not move. If the FSC lever moves back when the steering levers are pulled back, **the friction needs to be increased**.

2. With steering levers held back, move the FSC lever back from forward position. With a proper amount of friction adjusted, the FSC lever should move back with a slight amount of resistance (friction). If the FSC lever movement is “stiff” in this case, **the friction needs to be decreased**.

3. FSC friction is increased or decreased by loosening or tightening the friction nut as shown by Photo 5-19. Loosen or tighten nut and check control function until conditions of both (1) and (2) are met.

D. Electric Clutch (Commercial Model Only)

The electric clutch airgap needs to be adjusted if the clutch fails to engage or is slow to engage. Adjust as follows:

1. Make sure electric voltage applied at clutch is 12 volts or greater (with engine running).

2. Stop engine, remove ignition key and disconnect spark plug wire before adjusting clutch.

3. Disconnect electric clutch wires at connector plug and disconnect the clutch restraint strut by pulling back on the strut (against spring pressure). See Photo 5-8. Clutch body must be rotated for access to three (3) slots in body for adjustment.

4. Insert a .012” thick flat feeler gauge through one slot in clutch body and then between the rotor face and armature plate. See Photo 5-20.

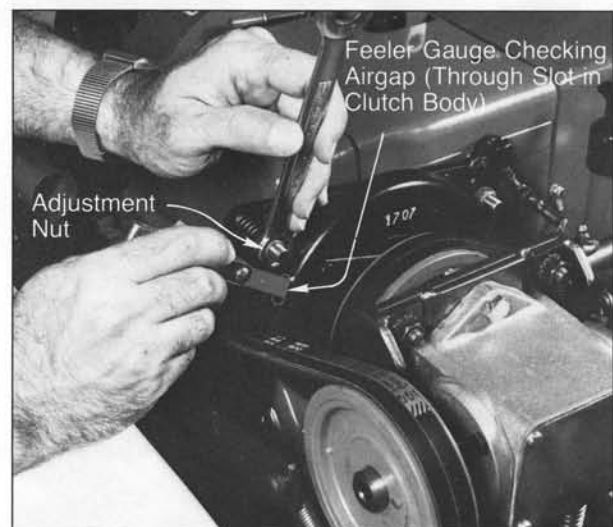

PHOTO 5-20 Electric Clutch Airgap Adjustment

5. Adjust (tighten or loosen) the nut adjacent to the slot being checked until the feeler gauge slides tightly between the armature and rotor face.

6. Repeat Steps (4) and (5) for the other two slots (three slots total). Rotate clutch body for easy access to all three slots.

7. After initial gap adjustment of all three slots, recheck and readjust all three slots until a tight fit of the feeler gauge is achieved at each location. Since adjustment of one nut affects the other two, each nut may have to be readjusted several times in order to give an equal airgap at each slot.

NOTE: Because of normal rotating tolerance of the rotor, the airgap will vary between .005/.020" **after the clutch is rotated.** This airgap range is normal and is the same range the factory uses to inspect and adjust new clutches.

8. Reconnect clutch restraint strut and clutch wiring.

E. Carburetor Adjustment

Carburetor adjustments are required to compensate for differences in altitude, temperature and fuel. Once the carburetor has been set, no further adjustments should be required. However, if the engine exhibits any of the following symptoms, the carburetor adjustment should be checked: black sooty exhaust smoke, lack of power, engine miss or backfire, hard to start, rough running or idle.

NOTE: Also refer to Engine Owner's Manual for detailed carburetor adjustment information.

NOTE: The air cleaner must be assembled to carburetor when adjusting carburetion.

| Engine | Main Jet | Idle Jet |
|--------------|----------------------------------|-------------------------------|
| 11-HP B & S | Lower Carburetor Bowl (1½ Turns) | Below Air Cleaner (1 Turn) |
| 16-HP Kohler | Top of Carburetor (2½ Turns) | Side of Carburetor (2½ Turns) |

TABLE 5-21 *Carburetor Needle Valve Location and Initial Setting*

- Gently close both carburetor needle valves (main or high speed needle and idle mixture needle) by turning clockwise until they bottom **lightly**.

IMPORTANT: Needle valves may be damaged by turning them too tight.

- Open needle valves (turn counterclockwise) to initial setting as shown by Table 5-21. This initial adjustment will permit the engine to be started and warmed up prior to final adjustment.

 **DANGER**

Engine must be running to adjust carburetor needle valves. To guard against injury, keep hands, feet, face and other parts of body away from muffler/exhaust pipe, other hot parts of engine and moving or rotating parts of engine.

- Start engine, allow to warm up (approximately 5 minutes) and open throttle to "FAST" position. Turn main needle valve in until engine slows (clockwise-lean mixture). Then turn out past smooth operating point until engine slows again (counterclockwise – rich mixture). Now turn needle valve to midpoint between rich and lean.

- Move throttle to "IDLE" position. Adjust idle speed for 1200 RPM by adjusting idle stop screw on carburetor butterfly valve (throttle).

- With engine idling, adjust idle mixture needle valve for smooth idle (set at midpoint between rich and lean mixture). Check engine acceleration from idle. If engine will not accelerate properly, the idle mixture should be readjusted, usually to a slightly richer mixture (open valve).

- Recheck idle speed after final idle mixture adjustment.

F. GHS Full Signal Adjustment

If the GHS full signal horn is not sounding or is not adjusted to sound when the catcher is full, then the following troubleshooting and adjustment instructions apply:

◆ GHS 3.2 with Air Pressure Switch

NOTE: These instructions also apply to earlier GHS 6.7 models (83-86).

Troubleshooting (When Horn Fails to Operate)

STEP 1 *Check the Horn*

Raise body and locate pressure switch mounted on side of blower discharge chute. Disconnect two wires from the pressure switch. Turn on ignition switch and connect the two wires together to make horn sound (bypassing switch).

- If horn does not sound, the horn is bad and needs to be replaced.
- If horn does sound, proceed to Step 2.

STEP 2 *Check the Pressure Switch*

Reconnect horn wires and disconnect pressure line from air separator. Blow gently (with mouth) into pressure tube to activate switch (ignition switch must be "On"). If horn does not sound, the switch is bad and needs to be replaced.

NOTE: Do not use pressurized air to blow into switch since this will burst switch diaphragm.

If the horn sounds, proceed to Step 3.

STEP 3 *Check the Air Separator*

Check air separator and orifice in grass chute for plugging which would prevent air pressure from activating the switch and horn.

Adjustment (When Horn Sounds at the Wrong Time)

STEP 1 *Raise body and locate pressure switch on side of blower discharge chute. An adjustment screw is located on the side of switch with a decal indicating direction of rotation to "DELAY" or "ADVANCE" horn signal.*

STEP 2 *Initial setting of switch is accomplished by turning adjustment screw out (counterclockwise) as far as possible and then turning in six (6) turns.*

STEP 3 *Lower body, start engine, engage mower blades and operate engine at full throttle (no grass in grass catcher). The full signal **horn should sound when full engine RPM is reached.** If horn does not sound, stop the mower and turn screw out (CCW) an additional ¼ turn and recheck for the horn signal at maximum RPM. If the horn sounds **before** full engine RPM is reached, turn the screw in (CW) by ¼ turn increments and recheck until the horn sounds only at full throttle.*

STEP 4 *Once the switch is adjusted to make the horn operate at maximum RPM (with no grass in grass catcher), turn the adjusting screw in (clockwise) two (2) turns to delay the signal until the grass catcher is full.*

STEP 5 *Steps 1 through 4 should be considered a course adjustment and some "trial and error" fine tuning may be required to make the horn sound when the catcher is full.*

◆ GHS 6.7 with Grass-Pak Switch

Troubleshooting (When Horn Fails to Operate)

STEP 1 *Check the Horn*

Disconnect two wires from "Grass-Pak" switch plug and make a jumper wire connection between these wires (bypassing switch). Turn on ignition switch and move blade clutch to "ENGAGED" position to make horn sound.

- If horn does not sound, the horn is bad and needs to be replaced.
- If horn does sound, proceed to Step 2.

STEP 2 *Check the Grass-Pak Switch*

Reconnect wires to Grass-Pak switch electric connector plug. Turn on ignition switch and move blade clutch to "ENGAGED" position (engine not running). Next, open catcher back door and use hand to trigger "Grass-Pak" vane as it oscillates. Horn should sound as switch is moved in both directions. If horn does not sound, the switch is bad and needs to be replaced.

Adjustment (When Horn Sounds at the Wrong Time)

Very little, if any, adjustment of the Grass-Pak switch is required. However, the vertical position of the switch vane is adjustable approximately $\frac{3}{4}$ " to "fine tune" the timing of the full signal. Loosen screw mounting vane on switch and adjust position of vane as follows:

- Move vane "UP" to delay signal.
- Move vane "DOWN" to advance signal.

It should be noted that it will not be possible to adjust the switch to give a signal at the precise instant the catcher is full for a wide variety of mowing conditions, e.g. wet heavy grass will fill the catcher differently than dry fluffy grass and cause the signal to come on a little sooner or later than usual. Primarily, the switch should be adjusted to give the full signal with a **little advance warning before overfilling and clogging** of the grass delivery chute begins (regardless of mowing conditions).

G. Blade Brake Action

The mower blade drive (and blower on GHS models) is equipped with a brake system to stop blades within 5 seconds after disengaging clutch. If the brake system malfunctions – blades do not stop within 5 seconds – the brake should be adjusted or repaired as follows:

Standard 11-HP Model

A belt scrubber brake acting on the PTO drive belt provides braking action. The brake action is adjusted by **springing or bending the scrubber mount** on GHS models and **bending the scrubber** on SD models. See Photo 5-22 and 5-23.

| Desired Brake Action | SD Model Direction of Scrubber Bend | GHS Model Direction of Mount Bend |
|----------------------|-------------------------------------|-----------------------------------|
| Stronger (Quicker) | Bend Up | Bend Mount Dn |
| Weaker (Slower) | Bend Down | Bend Mount Up |

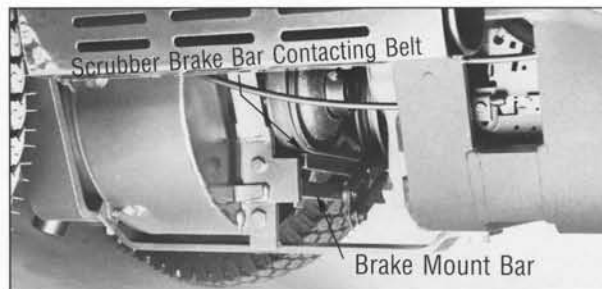

PHOTO 5-22 Scrubber Brake Adjustment on Standard GHS Model



PHOTO 5-23 Scrubber Brake Adjustment on Standard SD Model

Use "trial and error" to achieve a stopping time of approximately 4-5 seconds after disengaging clutch with full throttle. **Do not exceed 5 seconds.** Avoid stopping too quick as this reduces belt life (burns belt).

Also check for alignment of the brake bar (scrubber) on the belt and make sure bar is **only contacting the back of belt** and not the edges of the pulley(s). For GHS models, it may be necessary to spring the brake mount bar to shift (align) the brake bar on the belt and likewise the scrubber on SD models is bent for alignment with belt.

Commercial 16-HP Model

The electromagnetic clutch and brake assembly provides braking action for the mower blades and GHS blower. If the braking action is not within 5 seconds after clutch disengagement, the clutch airgap adjustment should be checked per paragraph D. If the brake continues to malfunction with correct airgap setting, the clutch assembly will need to be rebuilt or replaced.

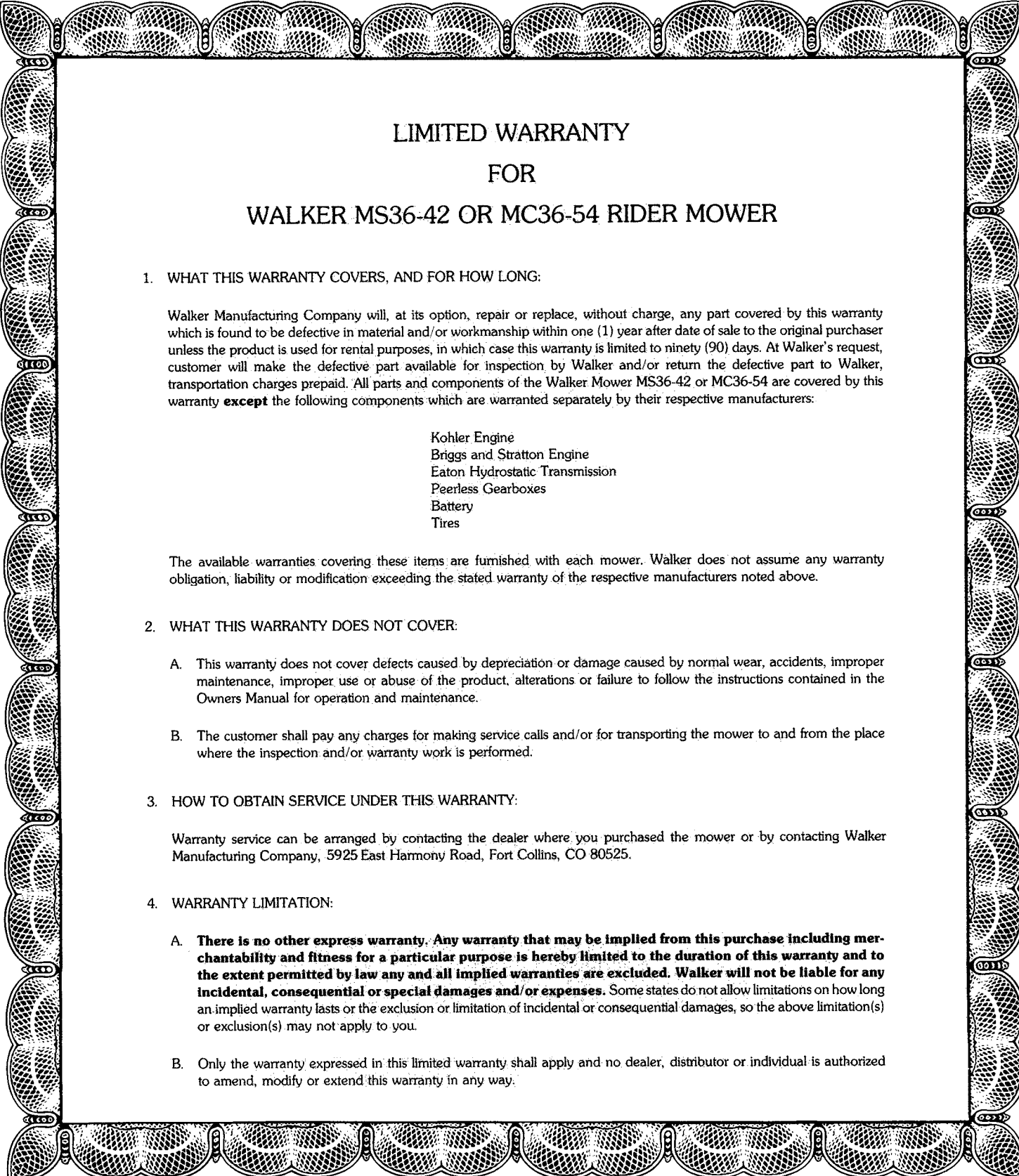

LIMITED WARRANTY FOR WALKER MS36-42 OR MC36-54 RIDER MOWER

1. WHAT THIS WARRANTY COVERS, AND FOR HOW LONG:

Walker Manufacturing Company will, at its option, repair or replace, without charge, any part covered by this warranty which is found to be defective in material and/or workmanship within one (1) year after date of sale to the original purchaser unless the product is used for rental purposes, in which case this warranty is limited to ninety (90) days. At Walker's request, customer will make the defective part available for inspection by Walker and/or return the defective part to Walker, transportation charges prepaid. All parts and components of the Walker Mower MS36-42 or MC36-54 are covered by this warranty **except** the following components which are warranted separately by their respective manufacturers:

Kohler Engine
Briggs and Stratton Engine
Eaton Hydrostatic Transmission
Peerless Gearboxes
Battery
Tires

The available warranties covering these items are furnished with each mower. Walker does not assume any warranty obligation, liability or modification exceeding the stated warranty of the respective manufacturers noted above.

2. WHAT THIS WARRANTY DOES NOT COVER:

- A. This warranty does not cover defects caused by depreciation or damage caused by normal wear, accidents, improper maintenance, improper use or abuse of the product, alterations or failure to follow the instructions contained in the Owners Manual for operation and maintenance.
- B. The customer shall pay any charges for making service calls and/or for transporting the mower to and from the place where the inspection and/or warranty work is performed.

3. HOW TO OBTAIN SERVICE UNDER THIS WARRANTY:

Warranty service can be arranged by contacting the dealer where you purchased the mower or by contacting Walker Manufacturing Company, 5925 East Harmony Road, Fort Collins, CO 80525.

4. WARRANTY LIMITATION:

- A. **There is no other express warranty. Any warranty that may be implied from this purchase including merchantability and fitness for a particular purpose is hereby limited to the duration of this warranty and to the extent permitted by law any and all implied warranties are excluded. Walker will not be liable for any incidental, consequential or special damages and/or expenses.** Some states do not allow limitations on how long an implied warranty lasts or the exclusion or limitation of incidental or consequential damages, so the above limitation(s) or exclusion(s) may not apply to you.
- B. Only the warranty expressed in this limited warranty shall apply and no dealer, distributor or individual is authorized to amend, modify or extend this warranty in any way.

